



WSEC 2018

nLight® Applications Guide





/ nLight Lighting Controls Platform

It's not just smarter. It's easier.

nLight is a digital lighting controls solution that offers wired and wireless lighting controls that easily connect luminaires, sensors, and other control devices to create a digital network.

The nLight platform of products enables ease in specification, installation, and ownership, making it the go-to digital lighting controls platform for specifiers, contractors, and building owners.



/ TABLE OF CONTENTS

- 04 Code Requirements for Common Building Spaces
- 05 How to Use This Guide
- 06 Enclosed Office Solutions
- 08 Open Plan Office Solutions
- 10 Conference Room Solutions
- 12 Classroom Solutions
- 14 Lobby Solutions
- 16 Corridor Solutions
- 18 Restroom Solutions
- 21 Stairwell Solutions
- 22 Warehouse Storage Solutions
- 23 Gymnasium Solutions
- 24 Parking Garage
- 25 Site Lighting
- 26 nLight Hybrid Networked Lighting Control
- 27 Requirements Overview
- 28 Emergency Lighting
- 29 Luminaires with Networked Embedded Controls from nLight



/ ABOUT

About WSEC

The Washington State Energy Code (WSEC) 2018 is a residential and commercial building energy code based on the International Energy Conservation Code (IECC) which has been adopted by many states and municipalities. The intention of this code is to reduce energy consumption by outlining design and construction requirements which include specific constraints for lighting controls. The use of lighting controls to synchronize light levels with daylight, occupancy, and multi-level control demand response capability are required in order to be compliant.

About This Guide

Acuity Brands® offers the nLight® WSEC Applications Guide as a reference of typical nLight layouts that help make code compliance quicker and easier.

The Acuity Brands Design Services Team is also available to support engineers and contractors with detailed design, submittal, and installation. For additional information, please contact your Acuity Brands Sales Representative.

About nLight

A Single Lighting Controls Platform for Indoor & Outdoor Spaces

nLight® is a distributed intelligence, lighting control platform that offers wired and wireless control products. Luminaires, sensors, switches, and other control devices create one solution that aids in code compliance, energy reduction, and advanced network capabilities. Ideal for any application, small to large, indoor to outdoor, nLight offers lighting controls that scale from one room to an entire floor, from one floor to an entire building, and from one building to an entire campus.

The chart below is an overview of the Code Requirements for Common Building Spaces. Please use this information as a guide. For specific code requirements please refer to the WSEC code.

	Control Requirement*	Code Provision ³	Code Summary ¹	Space Type										
				Enclosed Office	Open Plan Office	Conference, Meeting, Multipurpose Room	Classroom, Lecture Hall, Training Room	Lobby	Corridor	Public Restroom	Private Restroom	Storage	Non-Exit Stairwell	
On-Off Control	Manual-On or AutoOn ≤ 50%	C405.2.1.1.2	Automatically controlled spaces must be controlled to automatically turn the lighting on to not more than 50% power.	✓		✓	✓							
	Full Automatic-On	C405.2.1.1.2	Automatically controlled spaces are allowed to turn on to full.					✓	✓	✓	✓			✓
	Full Auto-Off via Occupancy Sensor	C405.2.1.1.1	Fixtures must automatically turn off within 20 minutes of all occupants leaving the space.	✓	✓	✓	✓	✓	✓	✓	✓	✓	✓	
	Time-Switch Controls (via System Controller)	C405.2.2	Each area of the building not provided with occupant sensor controls shall be provided with time switch controls. These areas must also be provided with a manual override switch.										(or)	
	Auto-Off ≤ 50%	C405.2.1.2	Occupancy sensors shall automatically reduce lighting in warehouse storage aisle-ways and open areas by ≤ 50%										and	
	Light Reduction Controls	C405.2.3.1	Spaces shall have a manual control that allows the occupant to reduce the connected lighting load uniformly by not less than 50%.		✓									✓
	Manual Control (Local Switch)	C405.2.3	Areas shall incorporate a manual control to allow occupants to turn fixtures off.	✓	(or)	✓	✓	✓	✓	✓	✓ ²	✓ ²		(or)
	Receptacle (i.e., Plug Load) Control	C405.10	50% of all receptacles shall be controlled by the occ sensor or time switch.	✓	✓	✓	✓							
Daylight Control	Daylight-Responsive Controls	C405.2.4 & C405.2.4.1	Daylight-responsive controls shall be provided within each space with sidelight and toplight daylight zones totaling > 150W with more than two general lighting fixtures..	✓	✓	✓	✓	✓	✓	✓	✓		✓	
Exterior Control	Exterior Lighting Controls	C405.2.6	C405.2.6.1 Daylight shutoff C405.2.6.2 Facade and landscape C405.2.6.3 Lighting setback C405.2.6.4 Exterior time-switch control function											

Gymnasium	Warehouse	Parking Garage	Site Lighting	Specific Applications (Display, Accent, Task, Under Cabinet)
	✓			✓
	(or)			
	✓		✓	✓
	and			
	✓			
✓				
(or)				
✓ ²				✓
✓	✓	✓		
		✓ ⁴	✓	

For each space type there will be a wired solution on the left and wireless solution on the right.

Room description: PRIVATE OFFICE: < 250 sq. ft., Windows, Luminaires with Networked Embedded Controls from nLight

Wire type legend

Bill of Materials				Bill of Materials			
Symbol	Qty	Product #	Description	Symbol	Qty	Product #	Description
[Luminaire Symbol]	2	See Note	Luminaires with Wired Networked Embedded Controls from nLight	[Luminaire Symbol]	2	See Note	Luminaires with Wireless Networked Embedded Controls from nLight
[Switch Symbol]	1	nWSX PDT LV DX	Wall Switch, Occupancy Sensor with On/Off, Raise/Lower	[Switch Symbol]	1	rPODB DX G2	On/Off, Raise/Lower WallPod [®]

Required list of devices in order to implement room layout design above

OPERATIONAL DETAILS:

- Light Fixtures:**
 - All fixtures are dimmable
 - All fixtures can be controlled together or independently
 - Maximum level can be task tuned to any percentage via programming
- Occupancy Control:**
 - Fixtures must be turned on manually (or optionally can be configured to come on automatically to 50%)
 - Fixtures turn off automatically when room becomes vacant
- Daylight Control:**
 - Not required for offices without windows or that have loads <150W in sidelight zones
- Manual Control:**
 - On/off & raise/lower control of fixtures

ADDITIONAL OPTIONS:

- Room can be connected to nLight backbone to enable network control or time schedules (C405.2.2.1 - Time-Switch Controls), and also qualify for Enhanced Digital Lighting Controls (C405.4). Note: Max of 4 fixtures per controlled group
- HVAC control available through system-wide ECLIPSE[®] interface option on the ECLIPSE[®] controller
- Luminaires with wireless networked embedded controls from nLight and occupancy daylighting sensor options available, please see the future specification sheet

Note: Contact your local lighting agent for more information on luminaires with networked embedded controls from nLight.

www.acuitybrands.com/nLight • 800-535-2465

Operational details describe the functionality provided by the equipment specified in the solution

Additional options that add control capacity beyond code requirements

Notes:

- This summary is for general information purposes only and is provided without any warranty as to accuracy, completeness, or otherwise. The user should read the applicable code sections for more complete and detailed descriptions of code requirements and exceptions and should consult with a professional engineer or other competent advisor before making any decision or taking any action based on this summary.
- While energy code is required, safety may preclude the use of a manual controls in these spaces.
- Lighting systems shall be provided with controls that comply with one of the following: nLight wired or wireless networked control devices addressing the requirements of Luminaire Level Lighting Controls (LLC) (C405.2.1, C405.2.3, and C405.2.5 OR C405.2.1 through C405.2.7).
- Exterior lighting control requirements apply to roof areas.

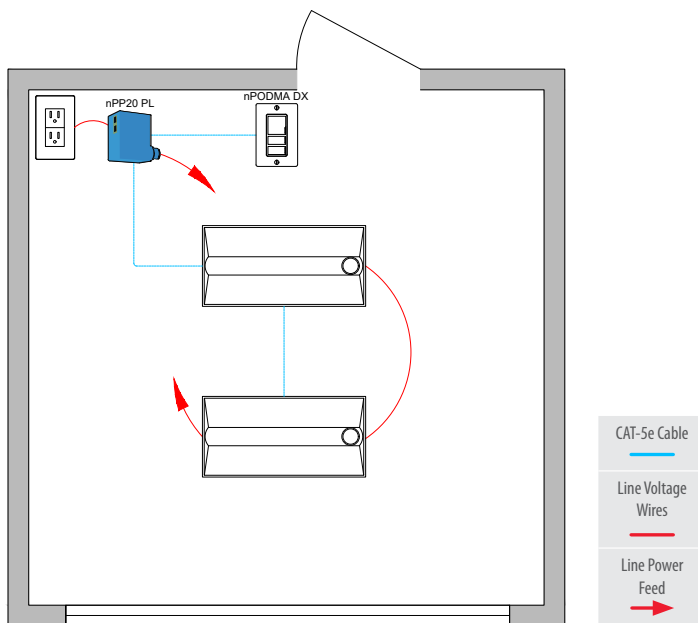

Wired



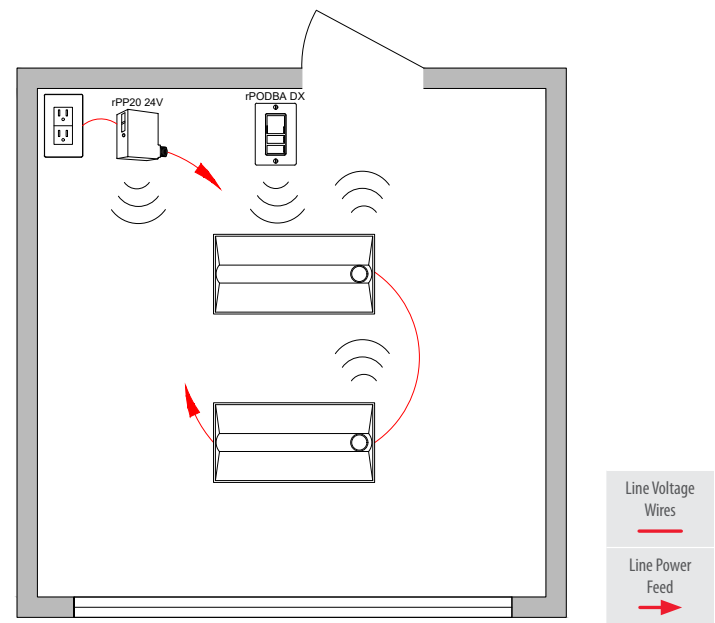

Wireless



Bill of Materials

Symbol	Qty	Product #	Description
	2	See Note	Troffer with Wired Networked Embedded Controls from nLight with Sensor Option
	1	nPODMA DX	On/Off, Raise/Lower WallPod®
	1	nPP20 PL	Plug Load Relay Pack

Bill of Materials

Symbol	Qty	Product #	Description
	2	See Note	Troffer with Wireless Networked Embedded Controls from nLight with Sensor Option
	1	rPODBA DX G2	Battery Powered, On/Off, Raise/Lower WallPod
	1	rPP20 24V EFP G2	Plug Load Relay Pack

/ OPERATIONAL DETAILS:

Light Fixtures:

- All fixtures are dimmable
- All fixtures can be controlled together or independently
- Maximum level can be task tuned to any percentage via programming

Occupancy Control:

- Fixtures must be turned on manually (or optionally can be configured to come on automatically to 50%)
- Fixtures turn off automatically when room becomes vacant
- Plug load turns on automatically

Daylight Control:

- Not required for offices without windows or that have two or fewer fixtures in the primary and secondary sidelit zones

Manual Control:

- On/off & raise/lower control of fixtures

Note: Contact your local lighting agent for more information on luminaires with networked embedded controls from nLight. nLight wired or wireless networked control devices address the requirements of Luminaire Level Lighting Controls (LLLC) (WESC 2018 CODE).

/ ADDITIONAL OPTIONS:

- Room can be connected to nLight backbone to enable network control or time schedules (C405.2.2 - Time-Switch Controls), and also qualify for Enhanced Digital Lighting Controls (C406.4)
- HVAC control available through system-wide BACnet® interface option on the ECLYPSE® controller
- Luminaires with wireless networked embedded controls from nLight and occupancy/daylighting sensor options available, please see the fixture specification sheet
- nLight wired or wireless networked control devices address the requirements of Luminaire Level Lighting Controls (LLLC) (C405.2).
- For emergency lighting control use a power pack with ER/EM option or luminaire with networked embedded controls from nLight with emergency option.
- Daylight zone controls are required if total proposed power is greater than 35% of the total power allowance as per C405.4.2 (C405.2.4)

Wired

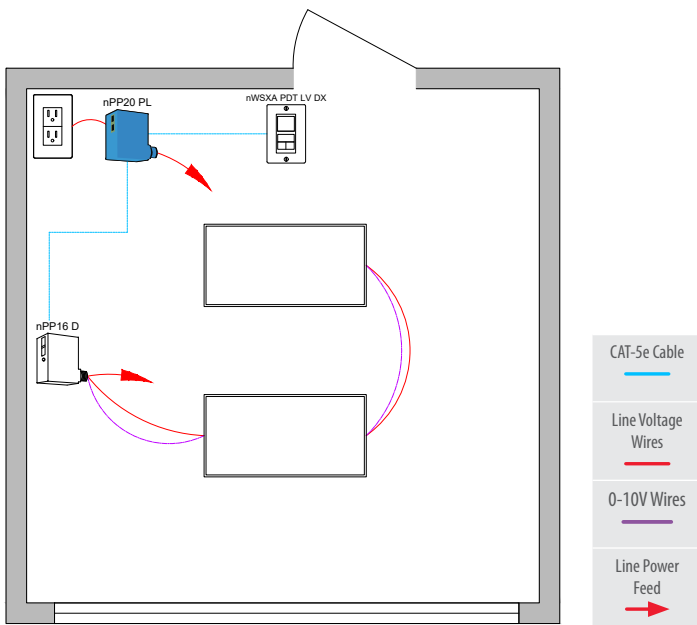

Wireless

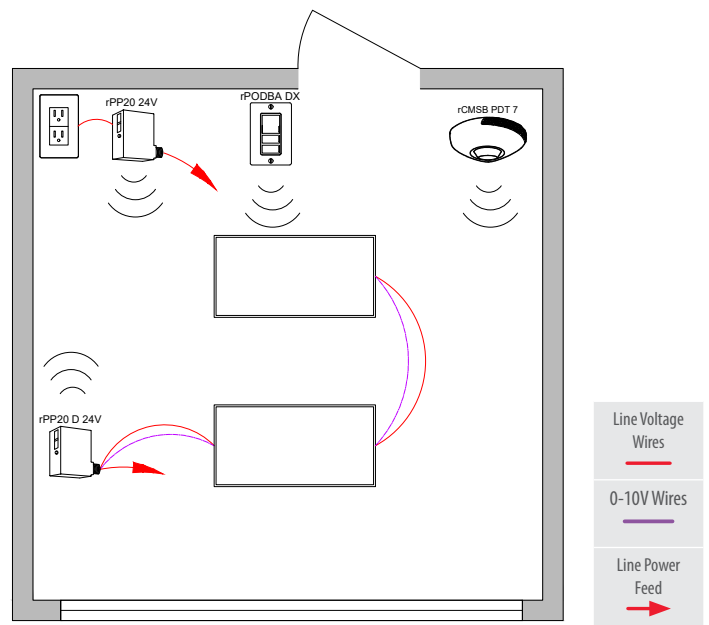

Bill of Materials

Symbol	Qty	Product #	Description
	1	nPP16 D EFP	Relay Pack with 0-10V Dimming Output
	1	nWSXA PDT LV DX	Wall Switch Occupancy Sensor with On/Off, Raise/Lower
	1	nPP20 PL	Plug Load Relay Pack

Bill of Materials

Symbol	Qty	Product #	Description
	1	rPP20 D 24V EFP G2	Relay Pack with 0-10V Dimming Output
	1	rPP20 24V EFP G2	Plug Load Relay Pack
	1	rPODBA DX G2	Battery Powered, On/Off, Raise/Lower WallPod
	1	rCMSB PDT 7 G2	Battery Powered Occupancy and Daylight Sensor

OPERATIONAL DETAILS:

Light Fixtures:

- All fixtures are dimmable
- All fixtures are controlled together
- Maximum level can be task tuned to any percentage via programming

Occupancy Control:

- Fixtures must be turned on manually (or optionally can be configured to come on automatically to 50%)
- Fixtures turn off automatically when room becomes vacant
- Plug load turns on automatically

Daylight Control:

- Not required for offices without windows or that have two or fewer fixtures in the primary and secondary sidelit zones

Manual Control:

- On/off & raise/lower control of fixtures

ADDITIONAL OPTIONS:

- Room can be connected to nLight backbone to enable network control or time schedules (C405.2.2 - Time-Switch Controls), and also qualify for Enhanced Digital Lighting Controls (C406.4)
- HVAC control available through system-wide BACnet® interface option on the ECLYPSE® controller
- For emergency lighting control use a power pack with ER/EM option or luminaire with networked embedded controls from nLight with emergency option.
- Daylight zone controls are required if total proposed power is greater than 35% of the total power allowance as per C405.4.2 (C405.2.4)

Wired

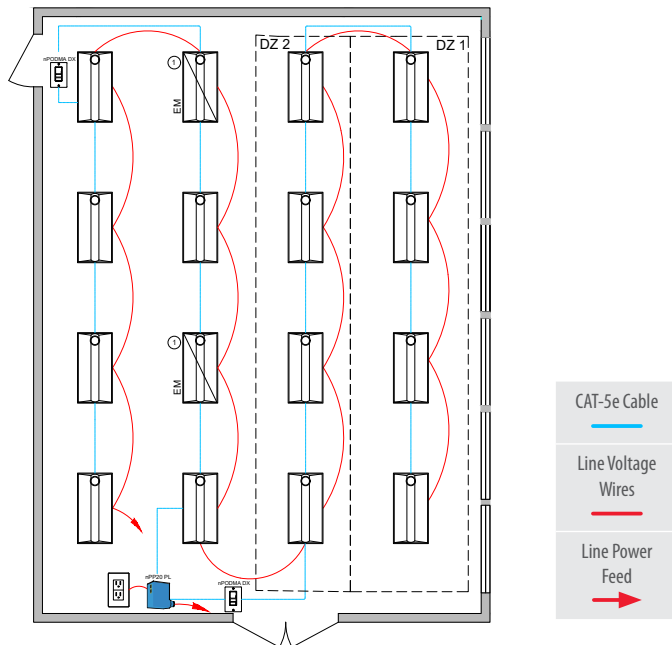

① Some luminaires with networked embedded controls from nLight require a normal sense line connection. Wiring shown assumes battery backup emergency option. See fixture spec sheets for details.

Bill of Materials

Symbol	Qty	Product #	Description
	14	See Note	Troffer with Wired Networked Embedded Controls from nLight with Sensor Option
	2	See Note	Troffer with Wired Networked Embedded Controls from nLight with Battery Option (typical) and Sensor Option
	2	nPODMA DX	On/Off, Raise/Lower WallPod
	1	nPP20 PL	Plug Load Relay Pack

OPERATIONAL DETAILS:

Light Fixtures:

- All fixtures are dimmable
- All fixtures are controlled together or independently
- Maximum level can be task tuned to any percentage via programming

Occupancy Control:

- Fixtures must be turned on manually (or optionally can be configured to come on automatically to 50%)
- Fixtures turn off automatically when room becomes vacant
- General lighting must be controlled in zones not greater than 600 sq. ft.
- Plug load turns on automatically

Daylight Control:

- Smooth continuous dimming
- Custom grouping of fixtures into separate daylight zones (max. number zones = number of fixtures)
- Not required for offices without windows or that have two or fewer fixtures in the primary and secondary sidelit zones

Manual Control:

- On/off & raise/lower control of fixtures

Note: Contact your local lighting agent for more information on luminaires with networked embedded controls from nLight. nLight wired or wireless networked control devices address the requirements of Luminaire Level Lighting Controls (LLLC) (WESC 2018 CODE).

Wireless

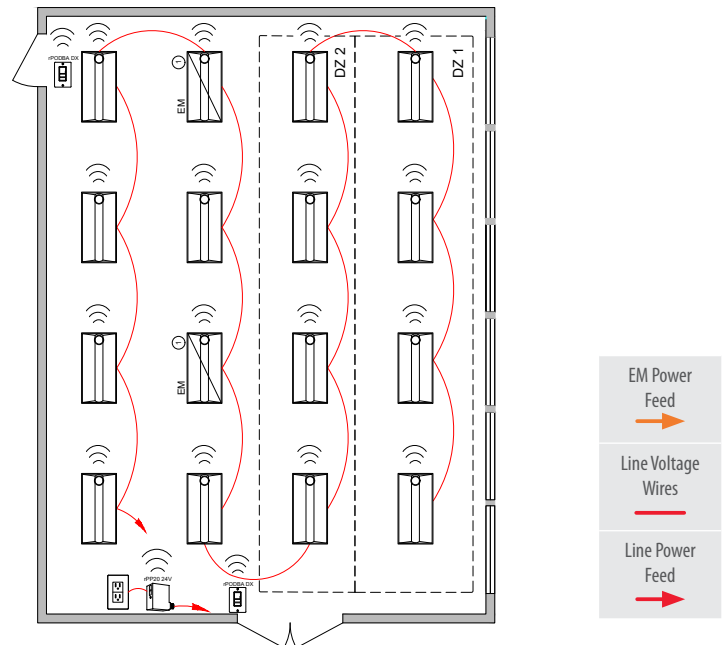

① Some luminaires with networked embedded controls from nLight require a normal sense line connection. Wiring shown assumes battery backup emergency option. See fixture spec sheets for details.

Bill of Materials

Symbol	Qty	Product #	Description
	14	See Note	Troffer with Wireless Networked Embedded Controls from nLight with Sensor Option
	2	See Note	Troffer with Wireless Networked Embedded Controls from nLight with Sensor and Emergency Option
	2	rPODBA DX G2	Battery Powered, On/Off, Raise/Lower WallPod
	1	rPP20 24V EFP G2	Plug Load Relay Pack

ADDITIONAL OPTIONS:

- Room can be connected to nLight backbone to enable network control or time schedules (C405.2.2 - Time-Switch Controls), and also qualify for Enhanced Digital Lighting Controls (C406.4)
- HVAC control available through system-wide BACnet® interface option on the ECLYPSE controller
- Luminaires with wireless networked embedded controls from nLight and occupancy/daylighting sensor options available, please see the fixture specification sheet
- nLight wired or wireless networked control devices address the requirements of Luminaire Level Lighting Controls (LLLC) (C405.2).
- Occupant sensor controls in open plan office spaces less than 300 sq. ft. in area shall comply with Section C405.2.1

Wired

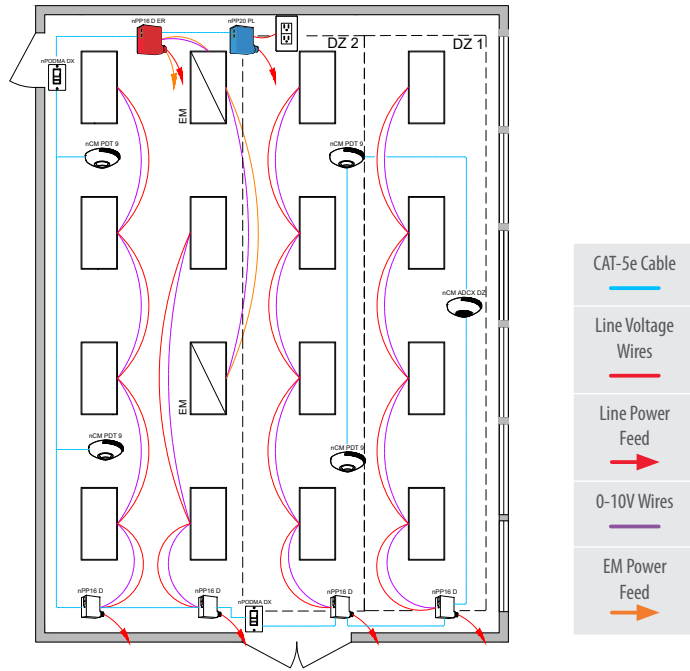

Wireless

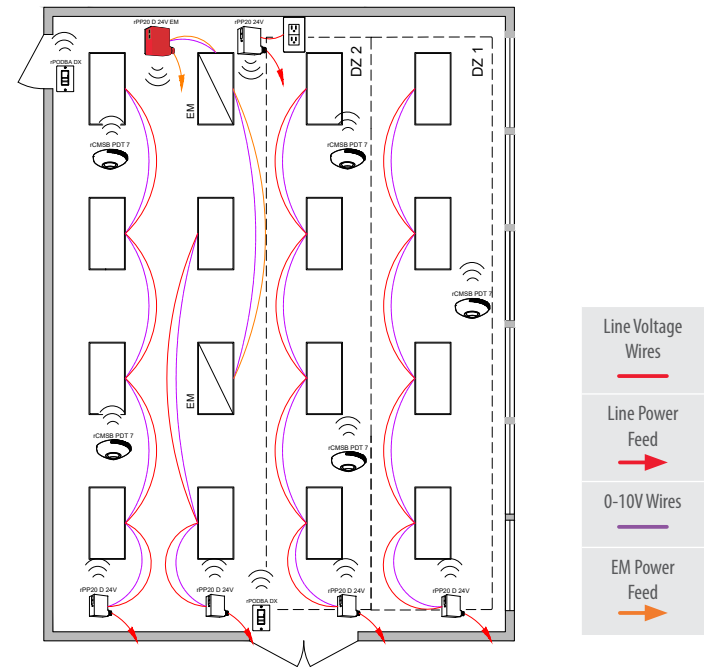

Bill of Materials

Symbol	Qty	Product #	Description
	4	nPP16 D EFP	Relay Pack with 0-10V Dimming Output
	1	nPP16 D ER EFP	Emergency Relay Pack with 0-10V Dimming Output
	2	nPODMA DX	On/Off, Raise/Lower WallPod
	4	nCM PDT 9 RJB	Occupancy Sensor
	1	nCM ADCX DZ RJB	Dual Zone Daylight Sensor
	1	nPP20 PL	Plug Load Relay Pack

Bill of Materials

Symbol	Qty	Product #	Description
	4	rPP20 D 24V EFP G2	Relay Pack with 0-10V Dimming Output
	1	rPP20 D 24V EM EFP G2	Emergency Relay Pack with 0-10V Dimming Output
	2	rPODBA DX G2	Battery Powered, On/Off, Raise/Lower WallPod
	5	rCMSB PDT 7 G2	Battery Powered Occupancy and Daylight Sensor
	1	rPP20 24V EFP G2	Plug Load Relay Pack

OPERATIONAL DETAILS:

Light Fixtures:

- All fixtures are dimmable
- Each row controlled independently
- Maximum level can be task tuned to any percentage via programming

Occupancy Control:

- Fixtures must be turned on manually (or optionally can be configured to come on automatically to 50%)
- Fixtures turn off automatically when room becomes vacant
- General lighting must be controlled in zones not greater than 600 sq. ft.
- Plug load turns on automatically

Daylight Control:

- Smooth continuous dimming
- Daylight zones defined by rows
- Not required for offices without windows or that have two or fewer fixtures in the primary and secondary sidelit zones

Manual Control:

- On/off & raise/lower control of fixtures

ADDITIONAL OPTIONS:

- Room can be connected to nLight backbone to enable network control or time schedules (C405.2.2 - Time-Switch Controls), and also qualify for Enhanced Digital Lighting Controls (C406.4)
- HVAC control available through system-wide BACnet® interface option on the ECLYPSE controller
- Occupant sensor controls in open plan office spaces less than 300 sq. ft. in area shall comply with Section C405.2.1

Wired

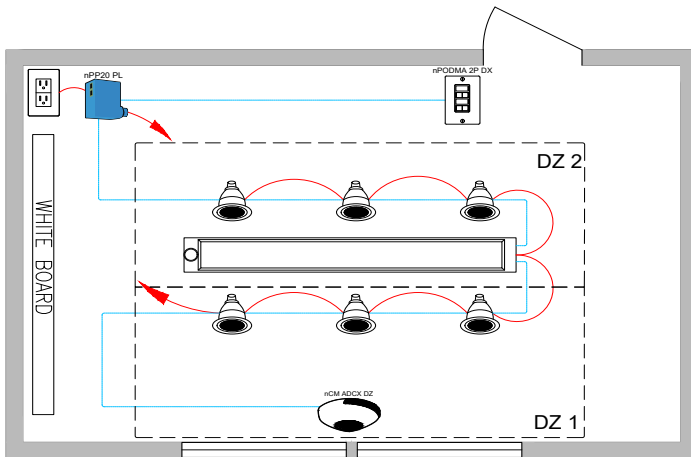

CAT-5e Cable

Line Voltage Wires

Line Power Feed

Wireless

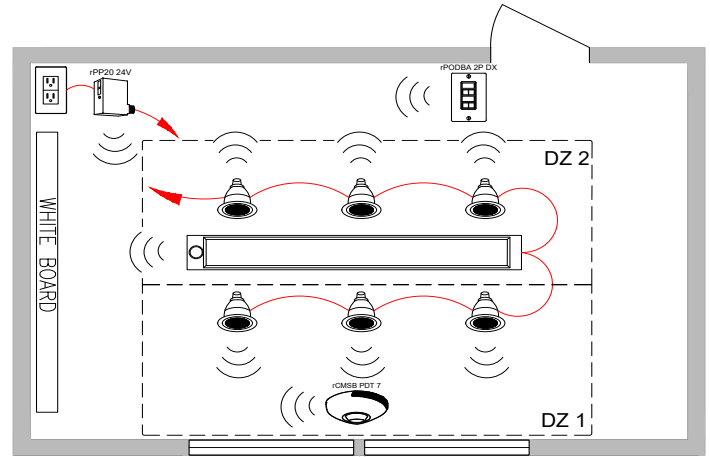

Line Voltage Wires

Line Power Feed

Bill of Materials

Symbol	Qty	Product #	Description
	1	See Note	Luminaire with Wired Networked Embedded Controls from nLight with Sensor Option
	6	See Note	Downlight with Wired Networked Embedded Controls from nLight
	1	nPODMA 2P DX	2-Pole, On/Off, Raise/Lower WallPod
	1	nPP20 PL	Plug Load Relay Pack
	1	nCM ADCX DZ RJB	Dual Zone Daylight Sensor

Bill of Materials

Symbol	Qty	Product #	Description
	1	See Note	Luminaire with Wireless Networked Embedded Controls from nLight with Sensor Option
	6	See Note	Downlight with Wireless Networked Embedded Controls from nLight
	1	rPODBA 2P DX G2	Battery Powered, 2-Pole, On/Off, Raise/Lower WallPod
	1	rPP20 24V EFP G2	Plug Load Relay Pack
	1	rCMSB PDT 7 G2	Battery Powered Occupancy and Daylight Sensor

OPERATIONAL DETAILS:

Light Fixtures:

- All fixtures are dimmable
- Maximum level can be task tuned to any percentage via programming
- A/V zone can be programmed to control two fixtures in front of the whiteboard

Occupancy Control:

- Fixtures must be turned on manually (or optionally can be configured to come on automatically to 50%)
- Fixtures turn off automatically when room becomes vacant
- Plug load turns on automatically

Daylight Control:

- Smooth continuous dimming
- Custom grouping of fixtures into separate daylight zones (max number zones = number of fixtures)
- Not required for areas without windows or that have two or fewer fixtures in the primary and secondary sidelit zones

Manual Control:

- On/off & raise lower control of two zones of fixtures

ADDITIONAL OPTIONS:

- Room can be connected to nLight backbone to enable network control or time schedules (C405.2.2 - Time-Switch Controls), and also qualify for Enhanced Digital Lighting Controls (C406.4)
- HVAC control available through system-wide BACnet® interface option on the ECLYPSE controller
- Luminaires with wireless networked embedded controls from nLight and occupancy/daylighting sensor options available, please see the fixture specification sheet
- nLight wired or wireless networked control devices address the requirements of Luminaire Level Lighting Controls (LLLC) (C405.2).
- For emergency lighting control use a power pack with ER/EM option or luminaire with networked embedded controls from nLight with emergency option.

Note: Contact your local lighting agent for more information on luminaires with networked embedded controls from nLight. nLight wired or wireless networked control devices address the requirements of Luminaire Level Lighting Controls (LLLC) (WESC 2018 CODE).

Wired

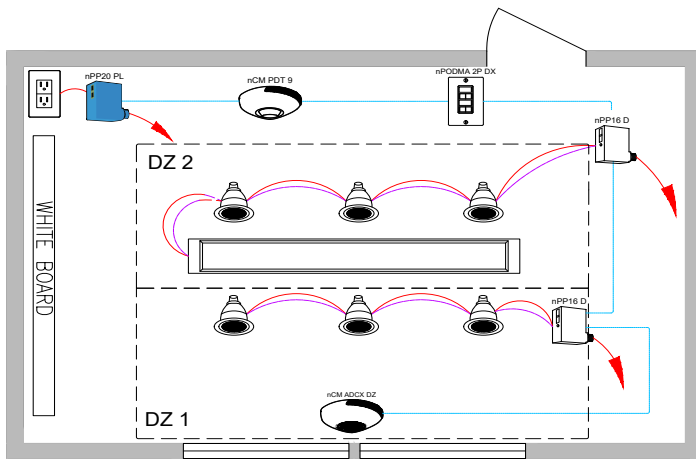

Wireless

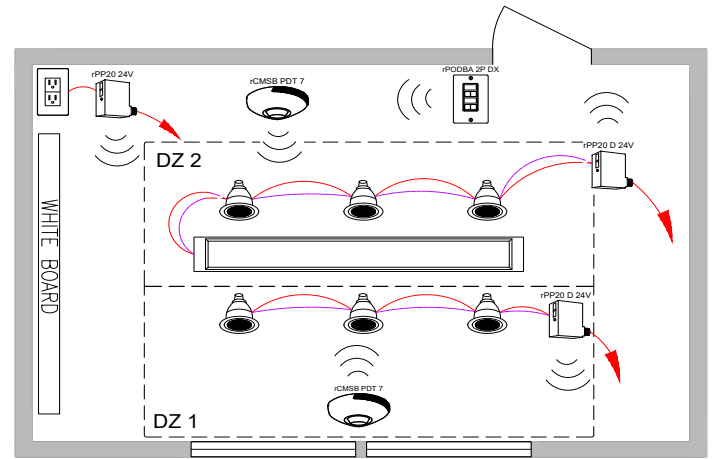

Bill of Materials

Symbol	Qty	Product #	Description
	2	nPP16 D EFP	Relay Pack with 0-10V Dimming Output
	1	nPODMA 2P DX	2-Pole, On/Off, Raise/Lower WallPod
	1	nCM PDT 9 RJB	Occupancy Sensor
	1	nCM ADCX DZ RJB	Dual Zone Daylight Sensor
	1	nPP20 PL	Plug Load Relay Pack

Bill of Materials

Symbol	Qty	Product #	Description
	2	rPP20 D 24V EFP G2	Relay Pack with 0-10V Dimming Output
	1	rPODBA 2P DX G2	Battery Powered, 2-Pole, On/Off, Raise/Lower WallPod
	2	rCMSB PDT 7 G2	Battery Powered Occupancy and Daylight Sensor
	1	rPP20 24V EFP G2	Plug Load Relay Pack

OPERATIONAL DETAILS:

Light Fixtures:

- All fixtures are dimmable
- Maximum level can be task tuned to any percentage via programming

Occupancy Control:

- Fixtures must be turned on manually (or optionally can be configured to come on automatically to 50%)
- Fixtures turn off automatically when room becomes vacant
- Plug load turns on automatically

Daylight Control:

- Smooth continuous dimming
- Daylight zones defined by rows
- Not required for areas without windows or that have two or fewer fixtures in the primary and secondary sidelit zones

Manual Control:

- On/off & raise lower control of two zones of fixtures

ADDITIONAL OPTIONS:

- Room can be connected to nLight backbone to enable network control or time schedules (C405.2.2 - Time-Switch Controls), and also qualify for Enhanced Digital Lighting Controls (C406.4)
- HVAC control available through system-wide BACnet® interface option on the ECLYPSE controller
- For emergency lighting control use a power pack with ER/EM option or luminaire with networked embedded controls from nLight with emergency option.



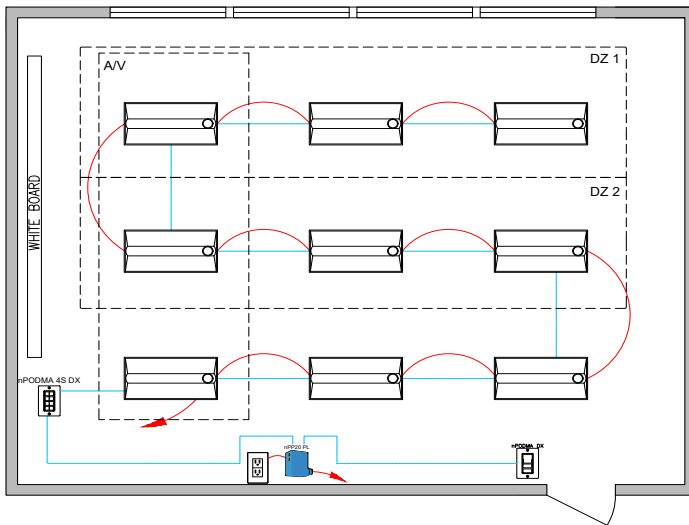

Wired

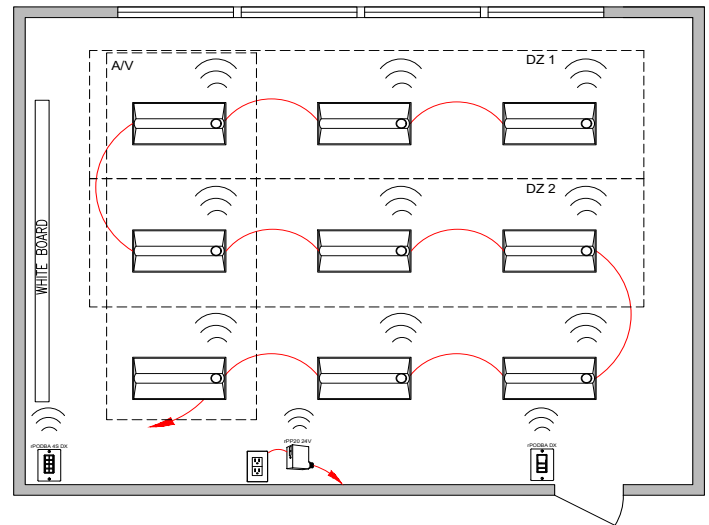





Wireless



Bill of Materials

Symbol	Qty	Product #	Description
	9	See Note	Troffer with Wired Networked Embedded Controls from nLight with Sensor Option
	1	nPODMA DX	On/Off, Raise/Lower WallPod
	1	nPP20 PL	Plug Load Relay Pack
	1	nPODMA 4S DX	Teacher Station — 4 Scene Control with Master On/Off & Raise/Lower

Bill of Materials

Symbol	Qty	Product #	Description
	9	See Note	Troffer with Wireless Networked Embedded Controls from nLight with Sensor Option
	1	rPODBA DX G2	Battery Powered, On/Off, Raise/Lower WallPod
	1	rPODBA 4S DX G2	Teacher Station — Battery Powered 4 Scene Control with Master On/Off & Raise/Lower
	1	rPP20 24V EFP G2	Plug Load Relay Pack

/ OPERATIONAL DETAILS:

Light Fixtures:

- All fixtures are dimmable
- All fixtures are controlled together or independently
- Maximum level can be task tuned to any percentage via programming

Occupancy Control:

- Fixtures must be turned on manually (or optionally can be configured to some on automatically to 50%)
- Fixtures automatically turn off when room becomes vacant
- Plug load turns on automatically

Daylight Control:

- Smooth continuous dimming
- Custom grouping of fixtures into separate daylight zones (max number zones = number of fixtures)
- Not required for areas without windows or that have two or fewer fixtures in the primary and secondary sidelit zones

Manual Control:

- On/off & raise/lower control of entire room
- Teacher station with 4 preset scenes

/ ADDITIONAL OPTIONS:

- Room can be connected to nLight backbone to enable network control or time schedules (C405.2.2 - Time-Switch Controls), and also qualify for Enhanced Digital Lighting Controls (C406.4)
- HVAC control available through system-wide BACnet® interface option on the ECLYPSE controller
- Luminaires with wireless networked embedded controls from nLight and occupancy/daylighting sensor options available, please see the fixture specification sheet
- nLight wired or wireless networked control devices address the requirements of Luminaire Level Lighting Controls (LLLC) (C405.2).
- For emergency lighting control use a power pack with ER/EM option or luminaire with networked embedded controls from nLight with emergency option.

Note: Contact your local lighting agent for more information on luminaires with networked embedded controls from nLight. nLight wired or wireless networked control devices address the requirements of Luminaire Level Lighting Controls (LLLC) (WESC 2018 CODE).

Wired

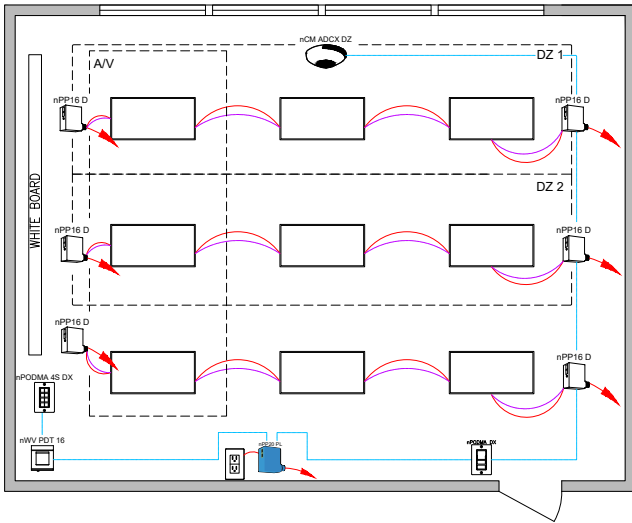

Wireless

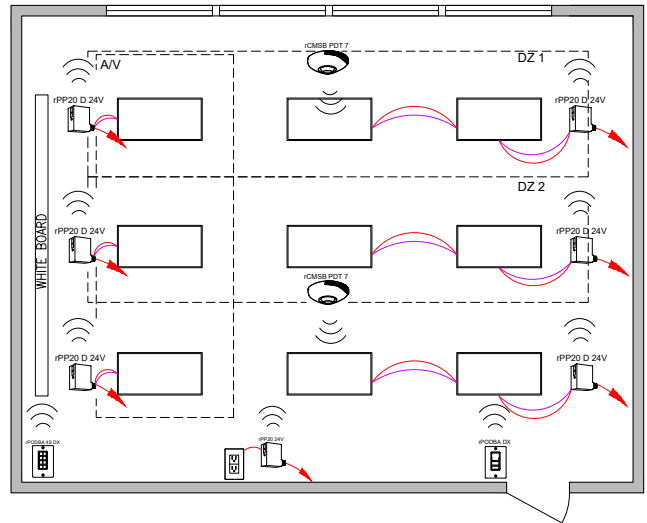

Bill of Materials

Symbol	Qty	Product #	Description
	6	nPP16 D EFP	Relay Module with 0-10V Dimming Output
	1	nPODMA DX	On/Off, Raise/Lower WallPod
	1	nWV PDT 16	Dual Technology Wide View Occupancy Sensor
	1	nPODMA 4S DX	Teacher Station — 4 Scene Control with Master On/Off & Raise/Lower
	1	nCM ADCX DZ RJB	Dual Zone Daylight Sensor
	1	nPP20 PL	Plug Load Relay Pack

Bill of Materials

Symbol	Qty	Product #	Description
	6	rPP20 D 24V EFP G2	Relay Pack with 0-10V Dimming Output
	1	rPODBA DX G2	Battery Powered, On/Off, Raise/Lower WallPod
	2	rCMSB PDT 7 G2	Battery Powered Occupancy and Daylight Sensor
	1	rPODBA 4S DX G2	Teacher Station — Battery Powered 4 Scene Control with Master On/Off & Raise/Lower
	1	rPP20 24V EFP G2	Plug Load Relay Pack

OPERATIONAL DETAILS:

Light Fixtures:

- All fixtures are dimmable
- Each row can be controlled independently
- Maximum level can be task tuned to any percentage via programming

Occupancy Control:

- Fixtures must be turned on manually (or optionally can be configured to come on automatically to 50%)
- Fixtures automatically turn off when room becomes vacant
- Plug load turns on automatically

Daylight Control:

- Smooth continuous dimming
- Daylight zones defined by rows
- Not required for areas without windows or that have two or fewer fixtures in the primary and secondary sidelit zones

Manual Control:

- Master on/off & raise/lower control of entire room
- Teacher station with 4 preset scenes

ADDITIONAL OPTIONS:

- Room can be connected to nLight backbone to enable network control or time schedules (C405.2.2 - Time-Switch Controls), and also qualify for Enhanced Digital Lighting Controls (C406.4)
- HVAC control available through system-wide BACnet® interface option on the ECLYPSE controller
- For emergency lighting control use a power pack with ER/EM option or luminaire with networked embedded controls from nLight with emergency option.

Wired

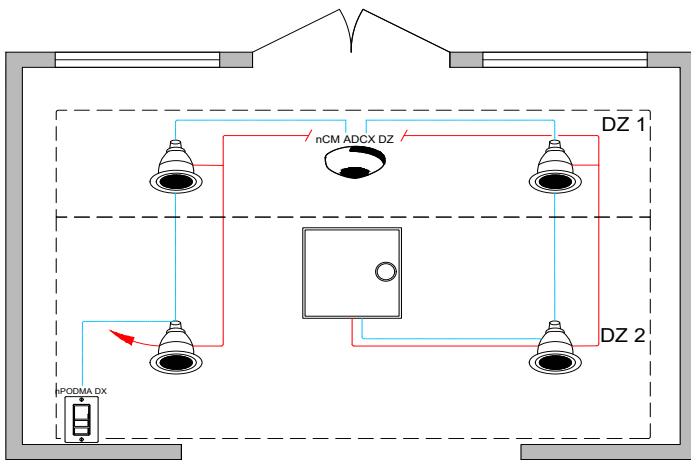

Wireless

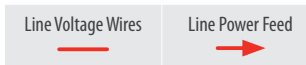
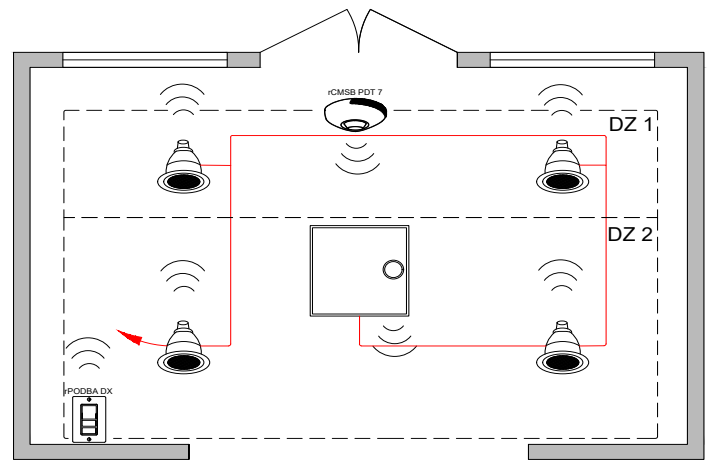

Bill of Materials

Symbol	Qty	Product #	Description
	4	See Notes	Downlight with Wired Networked Embedded Controls from nLight
	1	See Notes	Troffer with Wired Networked Embedded Controls from nLight with Sensor Option
	1	nPODMA DX	On/Off, Raise/Lower WallPod
	1	nCM ADCX DZ RJB	Dual Zone Daylight Sensor

Bill of Materials

Symbol	Qty	Product #	Description
	4	See Notes	Downlight with Wireless Networked Embedded Controls from nLight
	1	See Notes	Troffer with Wireless Networked Embedded Controls from nLight with Sensor Option
	1	rPODBA DX G2	Battery Powered, On/Off, Raise/Lower WallPod
	1	rCMSB PDT 7 G2	Battery Powered Occupancy and Daylight Sensor

OPERATIONAL DETAILS:

Light Fixtures:

- All fixtures are dimmable
- Maximum level can be task tuned to any percentage via programming

Occupancy Control:

- Fixtures automatically go to full bright when occupied
- Fixtures automatically turn off when room becomes vacant

Daylight Control:

- Smooth continuous dimming
- Custom grouping of fixtures into separate daylight zones (max number zones = number of fixtures)
- Not required for areas without windows or that have two or fewer fixtures in the primary and secondary sidelit zones

Manual Control:

- On/off & raise/lower control of fixtures

ADDITIONAL OPTIONS:

- Room can be connected to nLight backbone to enable network control or time schedules (C405.2.2 - Time-Switch Controls), and also qualify for Enhanced Digital Lighting Controls (C406.4)
- HVAC control available through system-wide BACnet® interface option on the ECLYPSE controller
- Luminaires with wireless networked embedded controls from nLight and occupancy/daylighting sensor options available, please see the fixture specification sheet
- nLight wired or wireless networked control devices address the requirements of Luminaire Level Lighting Controls (LLLC) (C405.2).
- For emergency lighting control use a power pack with ER/EM option or luminaire with networked embedded controls from nLight with emergency option.

Note: Contact your local lighting agent for more information on luminaires with networked embedded controls from nLight. nLight wired or wireless networked control devices address the requirements of Luminaire Level Lighting Controls (LLLC) (WESC 2018 CODE).

Wired

Wireless

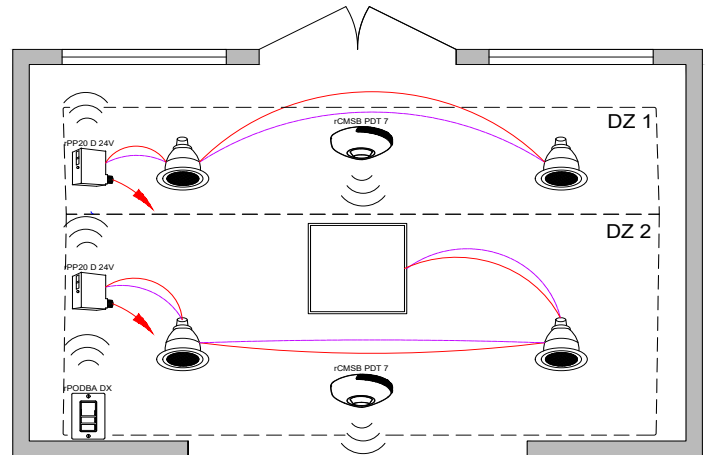
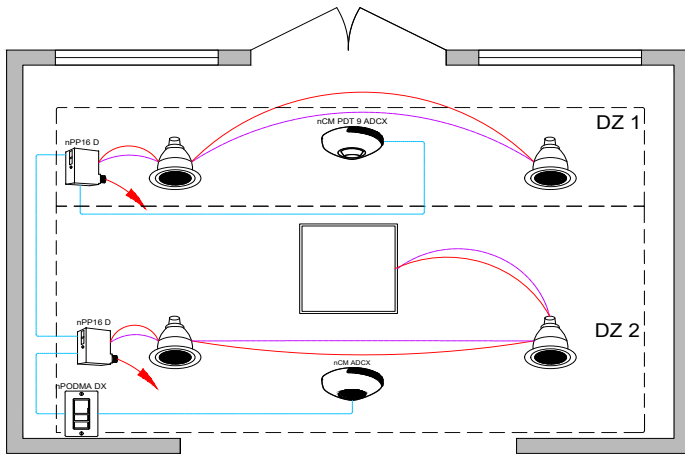

Bill of Materials

Bill of Materials

Symbol	Qty	Product #	Description
	2	nPP16 D EFP	Relay Pack with 0-10V Dimming Output
	1	nPODMA DX	On/Off, Raise/Lower WallPod
	1	nCM PDT 9 ADCX	Occupancy and Daylight Sensor
	1	nCM ADCX RJB	Daylight Sensor

Symbol	Qty	Product #	Description
	2	rPP20 D 24V EFP G2	Relay Pack with 0-10V Dimming Output
	1	rPODBA DX G2	Battery Powered, On/Off, Raise/Lower WallPod
	2	rCMSB PDT 7 G2	Battery Powered Occupancy and Daylight Sensor

OPERATIONAL DETAILS:

Light Fixtures:

- All fixtures are dimmable
- Maximum level can be task tuned to any percentage via programming

Occupancy Control:

- Fixtures automatically go to full bright when occupied
- Fixtures automatically turn off when room becomes vacant

Daylight Control:

- Smooth continuous dimming
- Daylight zones defined by relay module wiring
- Not required for areas without windows or that have two or fewer fixtures in the primary and secondary sidelit zones

Manual Control:

- On/off & raise/lower control of fixtures

ADDITIONAL OPTIONS:

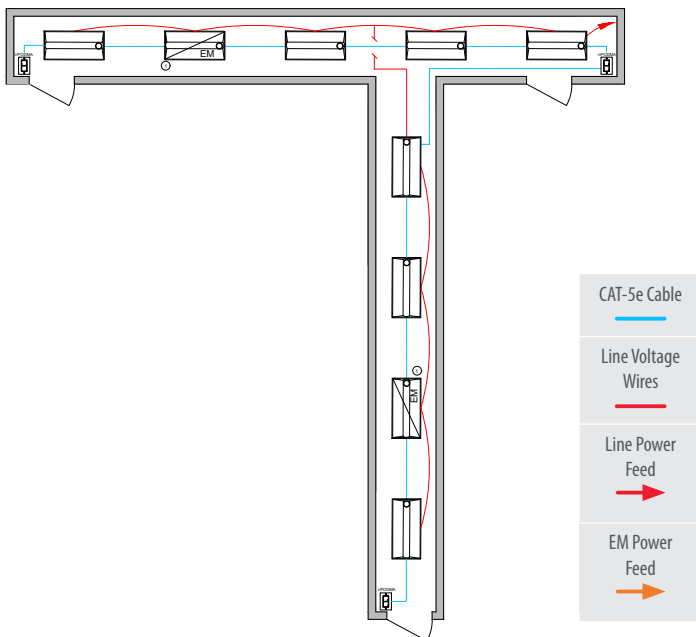

- Room can be connected to nLight backbone to enable network control or time schedules (C405.2.2 - Time-Switch Controls), and also qualify for Enhanced Digital Lighting Controls (C406.4)
- HVAC control available through system-wide BACnet® interface option on the ECLYPSE controller
- For emergency lighting control use a power pack with ER/EM option or luminaire with networked embedded controls from nLight with emergency option.

Wired



- ① Some emergency luminaires with networked embedded controls from nLight require a normal sense line connection. Wiring shown assumes battery backup emergency option. See fixture spec sheets for details.

Bill of Materials

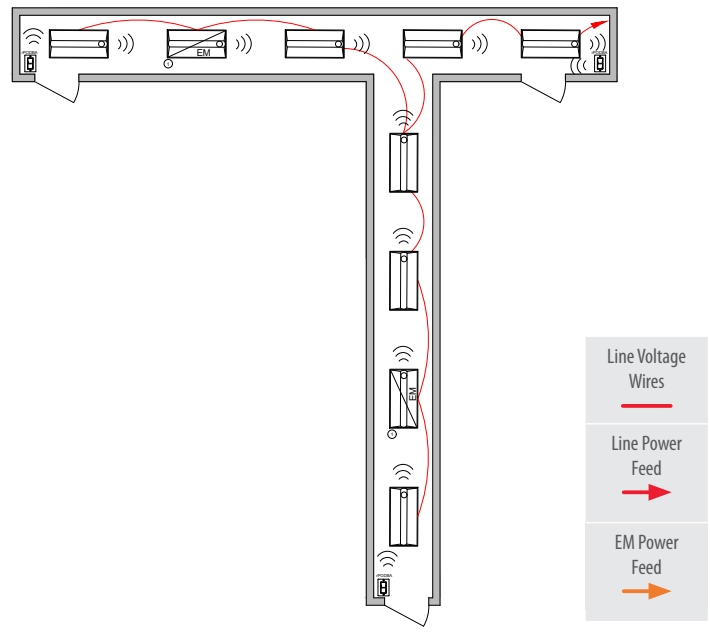

Symbol	Qty	Product #	Description
	7	See Note	Troffer with Wired Networked Embedded Controls from nLight with Sensor Option
	2	See Note	Troffer with Wired Networked Embedded Controls from nLight with Battery and Sensor Option
	3	nPODMA	On/Off WallPod

Wireless



- ① Some emergency luminaires with networked embedded controls from nLight require a normal sense line connection. Wiring shown assumes battery backup emergency option. See fixture spec sheets for details.

Bill of Materials

Symbol	Qty	Product #	Description
	7	See Note	Luminaires with Wireless Networked Embedded Controls from nLight with Sensor Option
	2	See Note	Troffer with Wireless Networked Embedded Controls from nLight with Battery and Sensor Option
	3	rPODBA G2	Battery Powered, On/Off, WallPod

/ OPERATIONAL DETAILS:

Light Fixtures:

- All fixtures are dimmable
- All fixtures are controlled together or independently
- Maximum level can be task tuned to any percentage via programming

Occupancy Control:

- Fixtures automatically go to full bright when occupied
- Fixtures automatically turn off or optionally can be configured to drop to low dim setting when space becomes vacant

Manual Control:

- On/off control of fixtures

Note: Contact your local lighting agent for more information on luminaires with networked embedded controls from nLight. nLight wired or wireless networked control devices address the requirements of Luminaire Level Lighting Controls (LLLC) (WESC 2018 CODE).

/ ADDITIONAL OPTIONS:

- Room can be connected to nLight backbone to enable network control or time schedules (C405.2.2 - Time-Switch Controls), and also qualify for Enhanced Digital Lighting Controls (C406.4)
- HVAC control available through system-wide BACnet® interface option on the ECLYPSE controller
- Luminaires with wireless networked embedded controls from nLight and occupancy/daylighting sensor options available, please see the fixture specification sheet
- nLight wired or wireless networked control devices address the requirements of Luminaire Level Lighting Controls (LLLC) (C405.2).



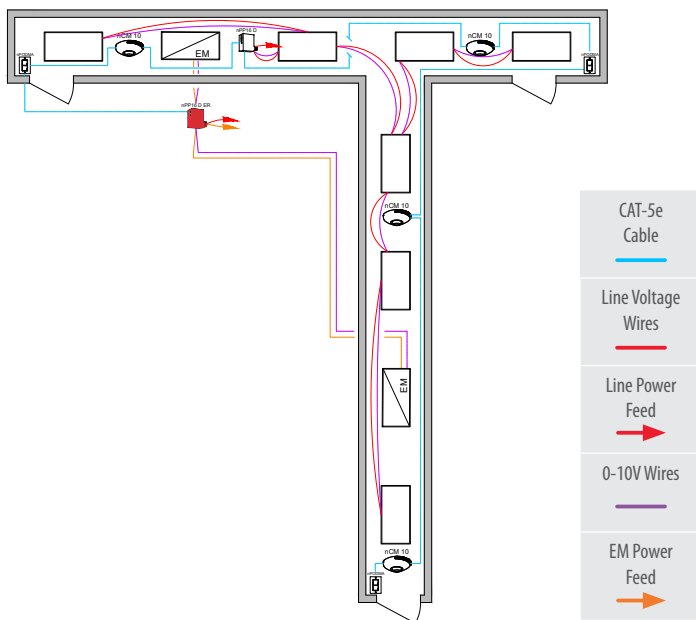

Wired

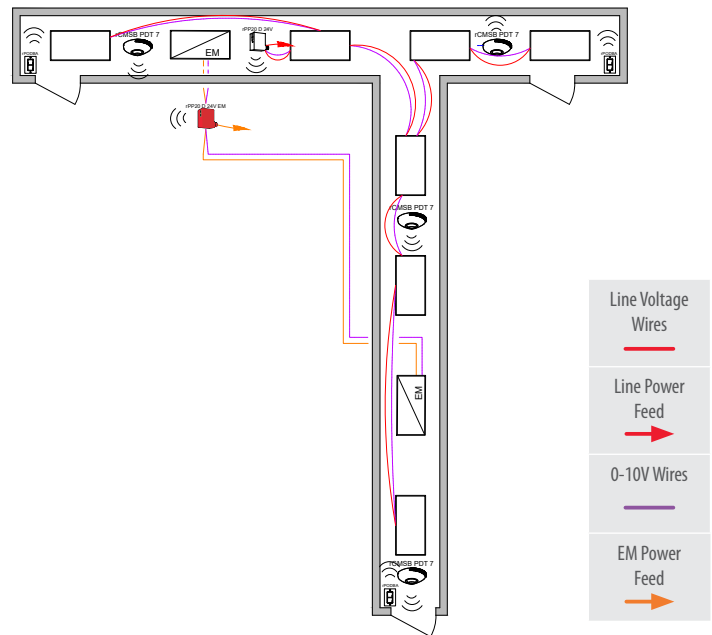





Wireless



Bill of Materials

Symbol	Qty	Product #	Description
	1	nPP16 D EFP	Relay Pack with 0-10V Dimming Output
	1	nPP16 D ER EFP	Emergency Relay Pack with 0-10V Dimming Output
	4	nCM 10 RJB	Occupancy Sensor
	3	nPODMA	On/Off WallPod

Bill of Materials

Symbol	Qty	Product #	Description
	1	rPP20 D 24V EFP G2	Relay Pack with 0-10V Dimming Output
	1	rPP20 D 24V EM EFP G2	Emergency Relay Pack with 0-10V Dimming Output
	4	rCMSB PDT 7 G2	Battery Powered Occupancy Sensor
	3	rPODBA G2	Battery Powered, On/Off, WallPod

/ OPERATIONAL DETAILS:

Light Fixtures:

- All fixtures are dimmable
- Maximum level can be task tuned to any percentage via programming

Occupancy Control:

- Fixtures automatically go to full bright when occupied
- Fixtures automatically turn off or optionally can be configured to drop to low dim setting when space becomes vacant

Manual Control:

- On/off control of fixtures

/ ADDITIONAL OPTIONS:

- Room can be connected to nLight backbone to enable network control or time schedules (C405.2.2 - Time-Switch Controls), and also qualify for Enhanced Digital Lighting Controls (C406.4)
- HVAC control available through system-wide BACnet® interface option on the ECLYPSE controller
- For emergency lighting control use a power pack with ER/EM option or luminaire with networked embedded controls from nLight with emergency option.

Wired

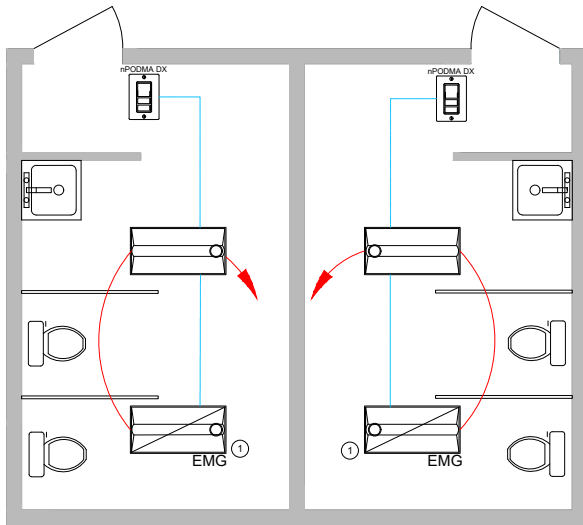

- ① Some emergency luminaires with networked embedded controls from nLight require a normal sense line connection. Wiring shown assumes battery backup emergency option. See fixture spec sheets for details.



Wireless

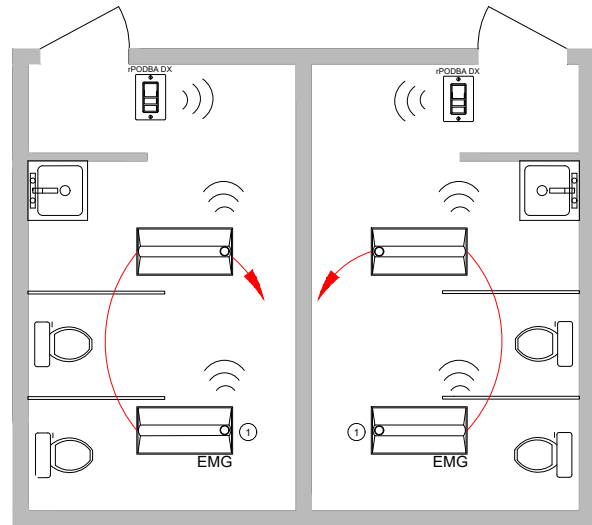

- ① Some emergency luminaires with networked embedded controls from nLight require a normal sense line connection. Wiring shown assumes battery backup emergency option. See fixture spec sheets for details.



Bill of Materials

Symbol	Qty	Product #	Description
	2	See Note	Troffer with Wired Networked Embedded Controls from nLight with Sensor Option
	2	See Note	Troffer with Wired Networked Embedded Controls from nLight with Battery and Sensor Option
	2	nPODMA DX	On/Off, Raise/Lower WallPod

Bill of Materials

Symbol	Qty	Product #	Description
	2	See Note	Troffer with Wireless Networked Embedded Controls from nLight with Sensor Option
	2	See Note	Troffer with Wireless Networked Embedded Controls from nLight with Sensor and Emergency Option
	2	rPODBA DX G2	Battery Powered, On/Off, Raise/Lower WallPod

/ OPERATIONAL DETAILS:

Light Fixtures:

- All fixtures are dimmable
- All fixtures are controlled together or independently (per room)
- Maximum level can be task tuned to any percentage via programming

Occupancy Control:

- Fixtures automatically go to full bright when occupied (or optionally can be configured to come on automatically to 50%)
- Fixtures automatically turn off or optionally can be configured to drop to low dim setting when space becomes vacant

Manual Control:

- On/off & raise/lower control of fixtures
- If switch poses safety concerns, optionally can be programmed for "on only"

/ ADDITIONAL OPTIONS:

- Room can be connected to nLight backbone to enable network control or time schedules (C405.2.2 - Time-Switch Controls), and also qualify for Enhanced Digital Lighting Controls (C406.4)
- HVAC control available through system-wide BACnet® interface option on the ECLYPSE controller
- Fixture embedded control and occupancy/daylighting sensor options available, please see the fixture specification sheet
- nLight wired or wireless networked control devices address the requirements of Luminaire Level Lighting Controls (LLLC) (C405.2).

Note: Contact your local lighting agent for more information on luminaires with networked embedded controls from nLight. nLight wired or wireless networked control devices address the requirements of Luminaire Level Lighting Controls (LLLC) (WESC 2018 CODE).

Wired

Wireless

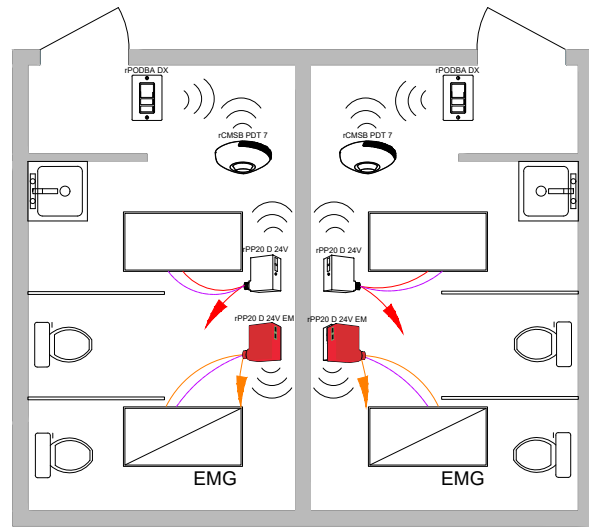
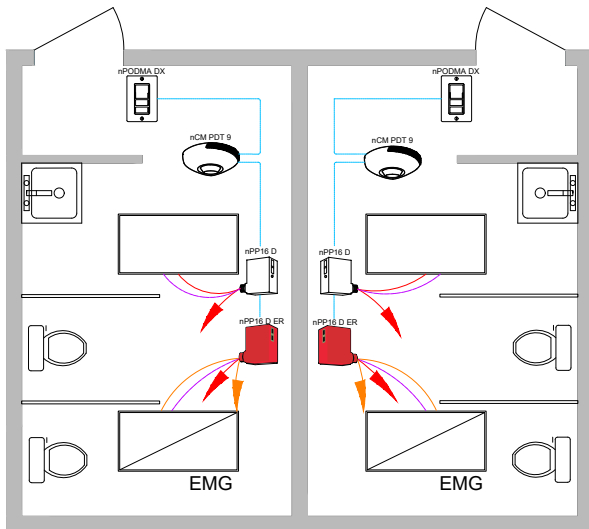

Bill of Materials

Symbol	Qty	Product #	Description
	2	nPP16 D EFP	Relay Pack with 0-10V Dimming Output
	2	nPP16 D ER EFP	Emergency Module with 0-10V Dimming Output
	2	nPODMA DX	On/Off & Raise/Lower WallPod
	2	nCM PDT 9 RJB	Occupancy Sensor

Bill of Materials

Symbol	Qty	Product #	Description
	2	rPP20 D 24V EFP G2	Relay Pack with 0-10V Dimming Output
	2	rPP20 D 24V EM EFP G2	Emergency Relay Pack with 0-10V Dimming Output
	2	rPODBA DX G2	Battery Powered, On/Off & Raise/Lower WallPod
	2	rCMSB PDT 7 G2	Battery Powered Occupancy Sensor

OPERATIONAL DETAILS:

Light Fixtures:

- All fixtures are dimmable
- All fixtures are controlled together or independently (per room)
- Maximum level can be task tuned to any percentage via programming

Occupancy Control:

- Fixtures automatically go to full bright when occupied (or optionally can be configured to come on automatically to 50%)
- Fixtures automatically turn off or optionally can be configured to drop to low dim setting when space becomes vacant

Manual Control:

- On/off & raise/lower control of fixtures
- If switch poses safety concerns, optionally can be programmed for "on only"

ADDITIONAL OPTIONS:

- Room can be connected to nLight backbone to enable network control or time schedules (C405.2.2 - Time-Switch Controls), and also qualify for Enhanced Digital Lighting Controls (C406.4)
- HVAC control available through system-wide BACnet® interface option on the ECLYPSE controller
- Luminaires with wireless networked embedded controls from nLight and occupancy/daylighting sensor options available, please see the fixture specification sheet
- For emergency lighting control use a power pack with ER/EM option or luminaire with networked embedded controls from nLight with emergency option.

Wired

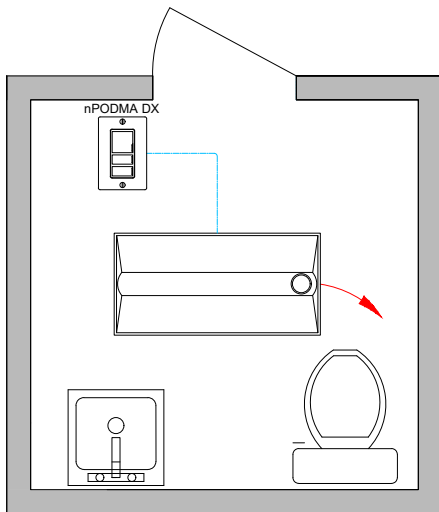

CAT-5e Cable

Line Voltage Wires

Line Power Feed

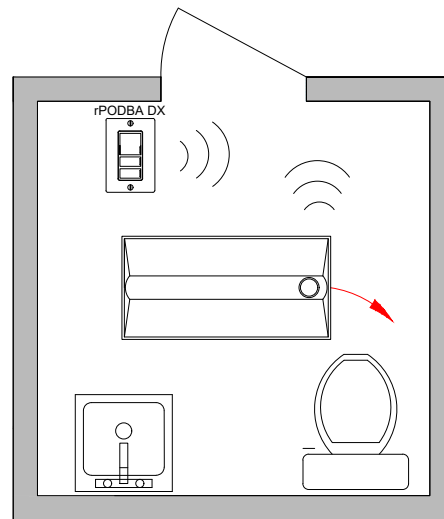

Wireless





Line Voltage Wires

Line Power Feed

Bill of Materials

Symbol	Qty	Product #	Description
	1	See Note	Troffer with Wired Networked Embedded Controls from nLight with Sensor Option
	1	nPODMA DX	On/Off, Raise/Lower WallPod

Bill of Materials

Symbol	Qty	Product #	Description
	1	See Notes	Troffer with Wireless Networked Embedded Controls from nLight with Sensor Option
	1	rPODBA DX G2	Battery Powered, On/Off, Raise/ Lower WallPod

/ OPERATIONAL DETAILS:

Light Fixtures:

- All fixtures are dimmable
- Maximum level can be task tuned to any percentage via programming

Occupancy Control:

- Fixtures automatically go to full bright when occupied (or optionally can be configured to come on automatically to 50%)
- Fixtures automatically turn off or optionally can be configured to drop to low dim setting when space becomes vacant

Manual Control:

- On/off & raise/lower control of fixtures
- If switch poses safety concerns, optionally can be programmed for "on only"

Note: Contact your local lighting agent for more information on luminaires with networked embedded controls from nLight. nLight wired or wireless networked control devices address the requirements of Luminaire Level Lighting Controls (LLC) (WESC 2018 CODE).

/ ADDITIONAL OPTIONS:

- Room can be connected to nLight backbone to enable network control or time schedules (C405.2.2 - Time-Switch Controls), and also qualify for Enhanced Digital Lighting Controls (C406.4)
- HVAC control available through system-wide BACnet® interface option on the ECLYPSE controller
- Luminaires with wireless networked embedded controls from nLight and occupancy/daylighting sensor options available, please see the fixture specification sheet
- nLight wired or wireless networked control devices address the requirements of Luminaire Level Lighting Controls (LLC) (C405.2).
- For emergency lighting control use a power pack with ER/EM option or luminaire with networked embedded controls from nLight with emergency option.

Luminaires with Wireless Networked Embedded Controls from nLight

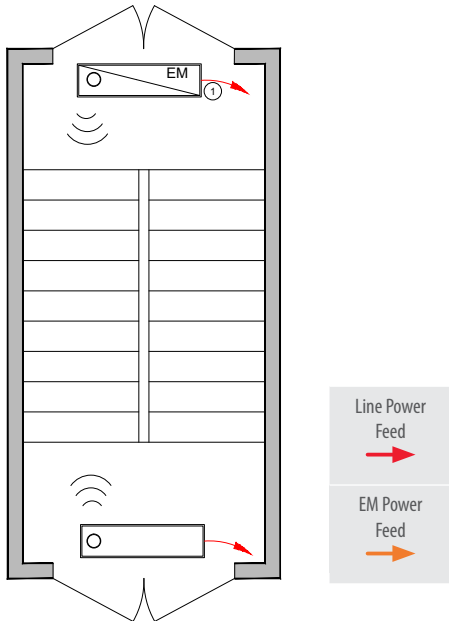

① Some emergency luminaires with networked embedded controls from nLight require a normal sense line connection. Wiring shown assumes battery backup emergency option. See fixture spec sheets for details.

Wireless with 0-10V Dimming Fixtures

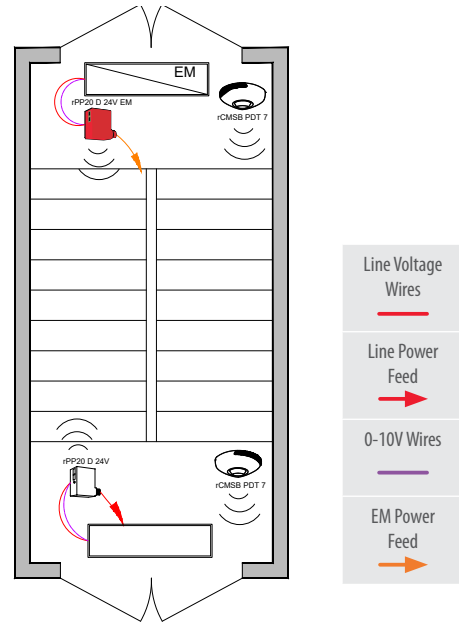

Bill of Materials

Symbol	Qty	Product #	Description
	1	See Note	Luminaire with Wireless Networked Embedded Controls from nLight with Sensor Option
	1	See Note	Luminaire with Wireless Networked Embedded Controls from nLight with Sensor and EM Option

Bill of Materials

Symbol	Qty	Product #	Description
	1	rPP20 D 24V EFP G2	Relay Pack with 0-10V Dimming Output
	1	rPP20 D 24V EM EFP G2	Emergency Relay Pack with 0-10V Dimming Output
	2	rCMSB PDT 7 G2	Battery Powered Occupancy Sensor

OPERATIONAL DETAILS:

Light Fixtures:

- All fixtures are dimmable
- Maximum level can be task tuned to any percentage via programming

Occupancy Control:

- Fixtures automatically go to full bright when occupied
- Fixtures automatically turn off or optionally can be configured to drop to low dim setting when space becomes vacant

Manual Control:

- Safety may preclude the use of a manual control in these areas

Note: Contact your local lighting agent for more information on luminaires with networked embedded controls from nLight. nLight wired or wireless networked control devices address the requirements of Luminaire Level Lighting Controls (LLLC) (WESC 2018 CODE).

ADDITIONAL OPTIONS:

- Room can be connected to nLight backbone to enable network control or time schedules (C405.2.2 - Time-Switch Controls), and also qualify for Enhanced Digital Lighting Controls (C406.4)
- HVAC control available through system-wide BACnet® interface option on the ECLYPSE controller
- Luminaires with wireless networked embedded controls from nLight and occupancy/daylighting sensor options available, please see the fixture specification sheet
- nLight wired or wireless networked control devices address the requirements of Luminaire Level Lighting Controls (LLLC) (C405.2).
- For emergency lighting control use a power pack with ER/EM option or luminaire with networked embedded controls from nLight with emergency option.

Luminaires with Wireless Networked Embedded Controls from nLight

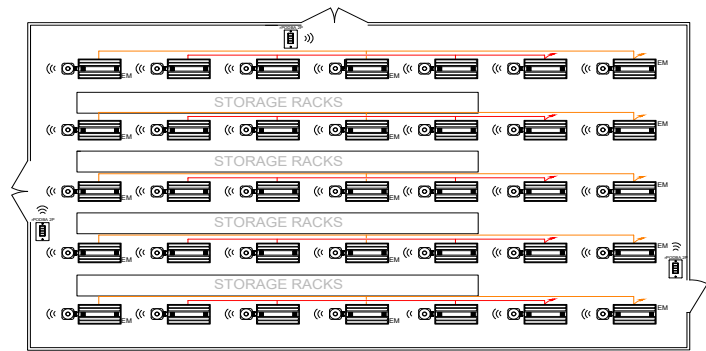

Bill of Materials

Symbol	Qty	Product #	Description
	20	See Note	High Bay with Wireless Networked Embedded Controls from nLight with Sensor Option
	15	See Note	High Bay with Wireless Networked Embedded Controls from nLight with Sensor and Emergency Option
	3	rPODBA 2P G2	Battery Powered, 2-Pole, On/Off WallPod

OPERATIONAL DETAILS:

Light Fixtures:

- All fixtures are dimmable
- Maximum level can be task tuned to any percentage via programming

Occupancy Control:

- Fixtures automatically go to full bright when occupied
- Fixtures automatically turn off or optionally can be configured to drop to low dim setting when space becomes vacant

Daylight Control:

- Daylight responsive controls lights to full off when adequate daylight present
- Not required for spaces without skylights or that have two or fewer fixtures in the primary and secondary sidelit zones

Note: Contact your local lighting agent for more information on luminaires with networked embedded controls from nLight. nLight wired or wireless networked control devices address the requirements of Luminaire Level Lighting Controls (LLLC) (WESC 2018 CODE).

Wireless with 0-10V Dimming Fixtures

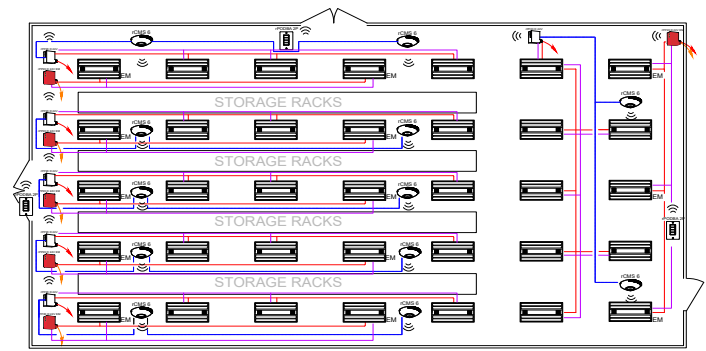

Bill of Materials

Symbol	Qty	Product #	Description
	6	rPP20 D 24V EFP G2	Relay Pack with 0-10V Dimming Output
	6	rPP20 D 24V EM EFP G2	Emergency Relay Pack with 0-10V Dimming Output
	3	rPODBA 2P G2	Battery Powered, 2-Pole, On/Off WallPod
	12	rCMS 6 G2	Occupancy Sensor

ADDITIONAL OPTIONS:

- Room can be connected to nLight backbone to enable network control or time schedules (C405.2.2 - Time-Switch Controls), and also qualify for Enhanced Digital Lighting Controls (C406.4)
- HVAC control available through system-wide BACnet® interface option on the ECLYPSE controller
- Luminaires with wireless networked embedded controls from nLight and occupancy/daylighting sensor options available, please see the fixture specification sheet
- nLight wired or wireless networked control devices address the requirements of Luminaire Level Lighting Controls (LLLC) (C405.2).

Luminaires with Wireless Networked Embedded Controls from nLight

Wireless with 0-10V Dimming Fixtures

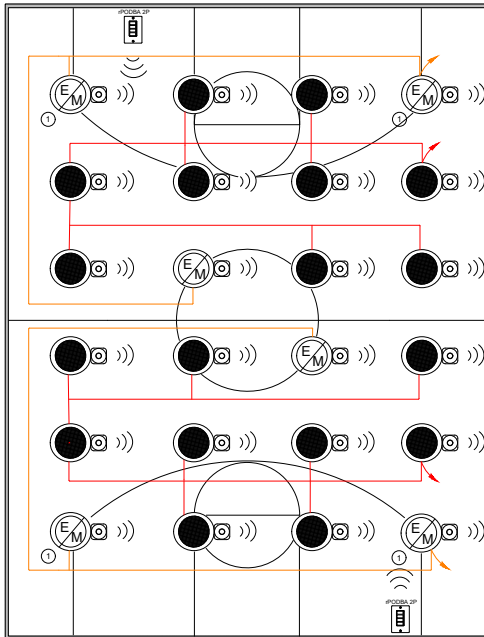

Ⓞ Fixture(s) assumed to include power interruption detection emergency option. For battery backup option, no dedicated EM circuit necessary.

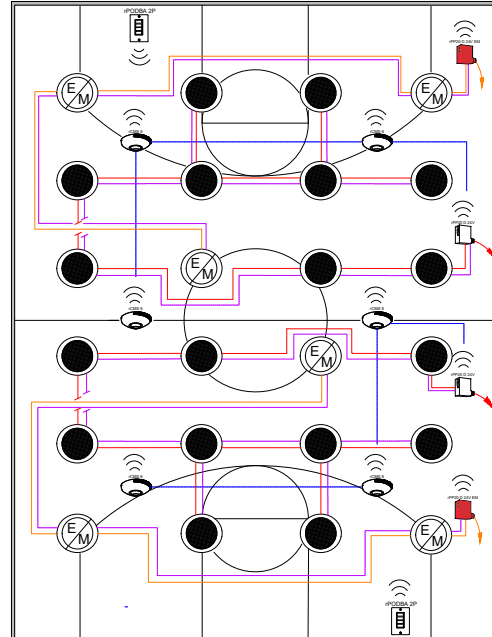

Bill of Materials

Symbol	Qty	Product #	Description
	18	See Notes	Luminaire with Wireless Networked Embedded Controls from nLight with Sensor Option
	6	See Notes	Luminaire with Wireless Networked Embedded Controls from nLight with Sensor and Emergency Option
	2	rPODBA 2P G2	Battery Powered, 2-Pole, On/Off WallPod

Bill of Materials

Symbol	Qty	Product #	Description
	2	rPP20 D 24V EFP G2	Relay Pack with 0-10V Dimming Output
	2	rPP20 D 24V EM EFP G2	Emergency Relay Pack with 0-10V Dimming Output
	2	rPODBA 2P G2	Battery Powered, 2-Pole, On/Off WallPod
	6	rCMS 6 G2	High Bay Occupancy Sensor

OPERATIONAL DETAILS:

Light Fixtures:

- All fixtures are dimmable
- Maximum level can be task tuned to any percentage via programming

Occupancy Control:

- Fixtures automatically go to full bright when occupied
- Fixtures automatically turn off or optionally can be configured to drop to low dim setting when space becomes vacant

Daylight Control:

- Daylight responsive controls lights to full off when adequate daylight present
- Not required for spaces without skylights or that have ltwo or fewer fixtures in the primary and secondary sidelit zones

ADDITIONAL OPTIONS:

- Room can be connected to nLight backbone to enable network control or time schedules (C405.2.2 - Time-Switch Controls), and also qualify for Enhanced Digital Lighting Controls (C406.4)
- HVAC control available through system-wide BACnet® interface option on the ECLYPSE controller
- Luminaires with wireless networked embedded controls from nLight and occupancy/daylighting sensor options available, please see the fixture specification sheet
- nLight wired or wireless networked control devices address the requirements of Luminaire Level Lighting Controls (LLC) (C405.2).

Note: Contact your local lighting agent for more information on luminaires with networked embedded controls from nLight. nLight wired or wireless networked control devices address the requirements of Luminaire Level Lighting Controls (LLC) (WESC 2018 CODE).

Wireless Parking Garage

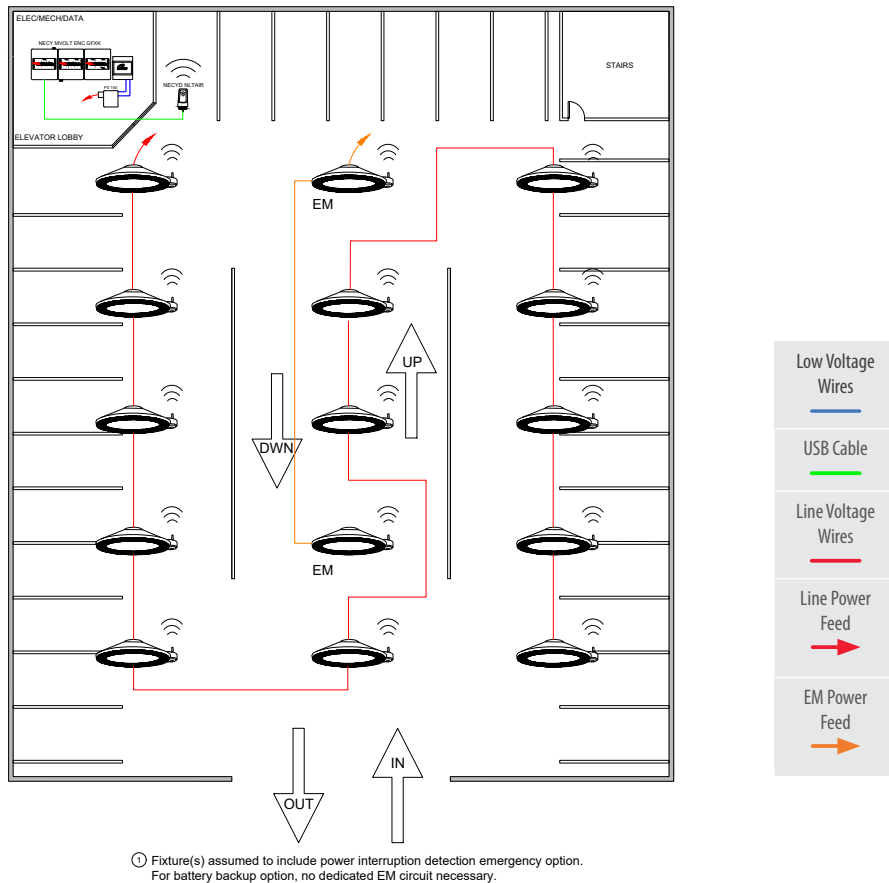

Bill of Materials

Symbol	Qty	Product #	Description
	13	See Note	Canopy with Wireless Networked Embedded Controls from nLight with Sensor Option
	2	See Note	Canopy with Wireless Networked Embedded Controls from nLight with Sensor and Emergency Option
	1	nECY	nLight ECLYPSE Network System Controller
	1	nECYD NLTAIR G2	nLight AIR Adapter

/ OPERATIONAL DETAILS:

Light Fixtures:

- All fixtures are dimmable
- All fixtures can be controlled together or independently
- Maximum level can be task tuned to any percentage via programming

Occupancy Control:

- Fixtures automatically go to full bright when occupied
- Fixtures automatically turn off or optionally can be configured to drop to low dim setting when space becomes vacant

Daylight Control:

- Daylight responsive controls lights to full off when adequate daylight present

/ ADDITIONAL OPTIONS:

- Devices can be connected to nLight backbone for embedded network control or time-switch control (C405.2.2.1). GFXK option can be added to nLight ECLYPSE to provide manual override (C405.2.2.1.5).
- Luminaires with wireless networked embedded controls from nLight and occupancy/daylighting sensor options available, please see the fixture specification sheet
- nLight wired or wireless networked control devices address the requirements of Luminaire Level Lighting Controls (LLLC) (C405.2).

Note: Contact your local lighting agent for more information on luminaires with networked embedded controls from nLight. nLight wired or wireless networked control devices address the requirements of Luminaire Level Lighting Controls (LLLC) (WESC 2018 CODE).

Wireless Site Lighting

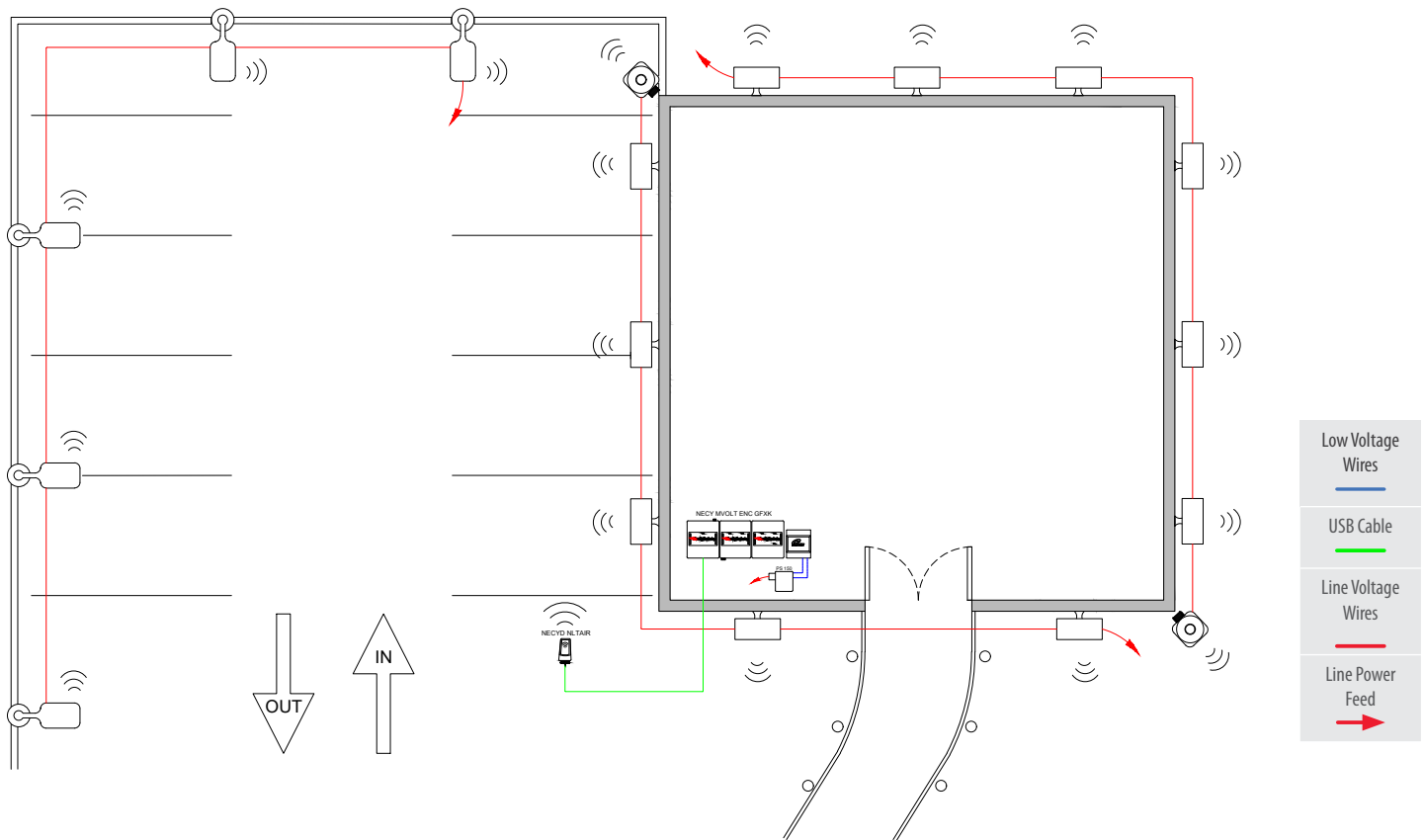

Bill of Materials

Symbol	Qty	Product #	Description
	5	See Note	Area Luminaire with Wireless Networked Embedded Controls from nLight
	5	See Note	Wall Mount Luminaire with Wireless Networked Embedded Controls from nLight
	1	nECY	nLight ECLYPSE Network System Controller
	1	nECYD NLTAIR G2	nLight AIR Adapter
	2	rSBOR	nLight AIR Sensor and Wireless Repeater

OPERATIONAL DETAILS:

Light Fixtures:

- All fixtures are dimmable
- All fixtures can be controlled together or independently
- Maximum level can be task tuned to any percentage via programming

Occupancy Control:

- Fixtures automatically go to full bright when occupied
- Fixtures automatically turn off or optionally can be configured to drop to low dim setting when space becomes vacant
- Fixture zones respond uniformly, including response to space-wide broadcasts

Daylight Control:

- Daylight responsive controls lights to full off when adequate daylight present



ADDITIONAL OPTIONS:

- Devices can be connected to nLight backbone for embedded network control or time schedules for facade and landscape lighting shutoff (C405.2.6.2), lighting setback (C405.2.6.3), & exterior time-switch control (C405.2.6.4). GFXK option can be added to nLight ECLYPSE to provide manual override (C405.2.5).
- Luminaires with wireless networked embedded controls from nLight and occupancy/daylighting sensor options available, please see the fixture specification sheet

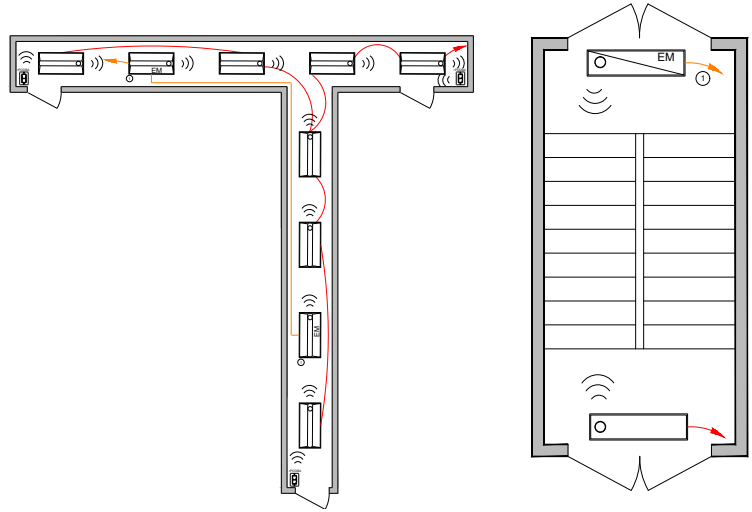
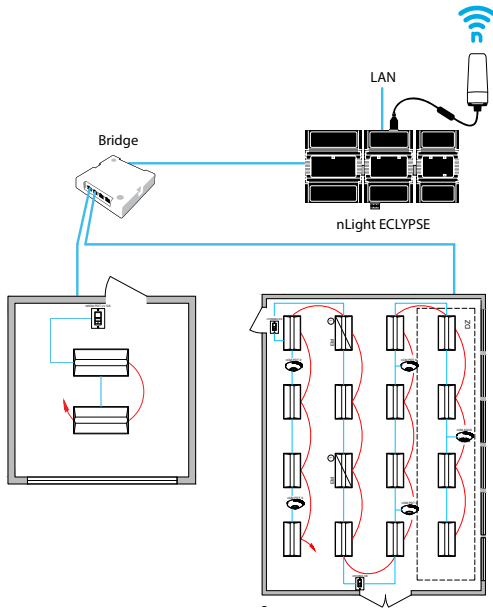
Note: Contact your local lighting agent for more information on luminaires with networked embedded controls from nLight. nLight wired or wireless networked control devices address the requirements of Luminaire Level Lighting Controls (LLC) (WSEC 2018 CODE).











Bill of Materials

Symbol	Qty	Product #	Description
	1	nBRG 8 KIT	8-Port Backbone Bridge
	1	nECY MVOLT ENC	nLight ECLYPSE Network System Controller and Optional BMS Interface
	1	nECYD NLTAIR G2	nLight AIR Adapter

Programmable Time Clock Control:

Although not pictured within each of the individual room design guides, each nLight controlled space can be connected via an nLight backbone to create a networked nLight lighting control system capable of meeting the requirements of WSEC 2018 Provision C405.2.2.1, Time-Switch Controls. A networked system also enables astronomical time clock control.

Control Requirement	Code Provision	nLight Solution Details	
Manual Control (Local Switch)	C405.2.3	nLight WallPod devices provide a user with local control of lighting within an nLight controlled space. WallPods are available in multiple styles – each with varying features and user experiences.	
		<p align="center">Push-Button WallPod</p>	<p align="center">Graphic WallPod*</p>
		<p>nPODMA Series rPODBA Series</p>  <p align="center">Traditional tactile buttons and LED user feedback.</p>	<p>nLight UNITOUCH Touchscreen Wall Switch</p>  <p align="center">Full-color touch screen provides a sophisticated look and feel.</p>
Shut-Off Control Time-Switch Controls and Exterior Lighting Control (via System Controller)	C405.2.2.1 C405.2.6.1 C405.2.6.2 C405.2.6.3 C405.2.6.4	Individual nLight control groups (i.e.: rooms) can be easily networked together across an entire building simply by connecting them into a “backbone” made up of one or more nLight bridge devices and/or nLight AIR adapters and an nLight ECLYPSE system controller. The system controller provides programmable time clock functionality for an nLight network as well as interfaces to the SensorView suite of web-based software applications (via an Ethernet LAN / WAN connection).	
		<p align="center">Network System Controller</p>	
		<p>Network System Controller</p>  <p>Additional benefits of installing an nLight backbone include remote status monitoring, system-wide configuration changes, and BMS interface capability.</p>	
Full Auto-Off via Occupancy Sensor	C405.2.1.1.1	nLight occupancy sensors utilize 100% digital passive infrared (PIR) detection, come in several mounting styles, and offer multiple coverage pattern options. Additionally, nLight sensors are available with patented Microphonics™ dual technology detection for rooms with obstructions. Configuring for full off vs. partial off control is done with system programming.	
Manual On, Auto-On <=50%, Full Automatic On	C405.2.1.1.2	<p align="center">360° Occupancy Sensor</p>	<p align="center">120° WideView Corner Sensor*</p>
		<p>nCM Series rCMS Series rCMSB Series</p> 	<p>nWV Series</p> 
		<p align="center">Surface mounts to ceiling tiles or sheetrock/plaster.</p>	<p align="center">Directly mounts in corner or to ceiling via repositionable ceiling bracket.</p>
Light-Level Control Light-Reduction Controls	C405.2.3.1	nLight provides multiple options for controlling continuous dimming luminaires. This allows spaces with several lighting types and technologies to be controlled together and with a common user experience.	
		<p align="center">Acuity Brands Luminaires with Networked Embedded Controls from nLight</p> 	<p align="center">Dimming Relay Packs</p> <p>nPP16 Series rPP20 Series</p> 
		<p>Acuity Brands offers a wide variety of LED fixtures with factory installed integrated nLight controls that provide smooth continuous dimming.</p>	<p>nLight dimming relay enable control of any 0-10VDC dimmable LED luminaire.</p>
Daylight-Responsive Controls	C405.2.4 C405.2.4.1	nLight offers standalone daylight harvesting sensors as well as occupancy sensors with integrated daylight harvesting. Sensors are available in various housings and provide continuous dimming control of any/all luminaires with networked embedded controls from nLight or dimming relay packs, each capable of being its own daylight zone.	
		<p align="center">Ceiling Mount Dimming Photocell</p>	<p align="center">Recessed Mount Dimming Photocell*</p>
		<p>nCM Series rCMSB Series</p> 	<p>nRM Series</p> 

*Available with nLight Wired products only.

Note: This summary is for general information purposes only and is provided without any warranty as to accuracy, completeness, or otherwise. The user should read the applicable code sections for more complete and detailed descriptions of code requirements and exceptions and should consult with a professional engineering or other competent advisor before making any decision or taking any action based on this summary.

2018 WSEC and Emergency Lighting

The nLight platform offers flexible, UL924 compliant control of emergency lighting. It addresses the needs of conventional projects that use extra wiring to charge battery packs inside of fixtures or to tell control devices to enter an emergency state when normal power is lost. Traditional lighting controls would make use of a shunt device in addition to a lighting control device (Figure 1). nLight consolidates the shunt device and lighting control device into a single digital device, which reduces installation and maximizes control (Figure 2). Wireless products also offer power interruption detection to initiate emergency control when normal power is lost. This modern method removes the need for extra wiring, further reducing the cost of installing emergency controls without sacrificing the intelligence and configurability that is expected from nLight devices (Figure 3).

Generally speaking, lighting that is normally on during occupied periods, normally dimmed or off during unoccupied periods, and also used to provide for egress during emergency power conditions should be controlled in compliance with C405.2. nLight features various UL924 listed options that can be specified to provide both lighting control in compliance with WSEC and emergency operation in compliance with locally enforced fire codes.

Traditional Shunt

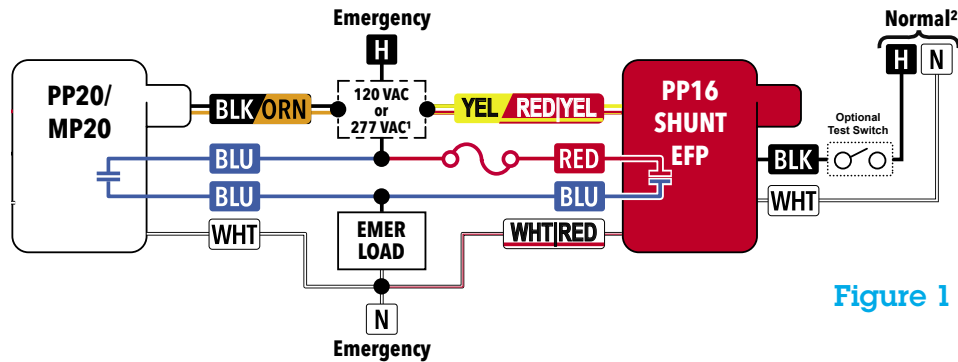

Figure 1

Single Phase with Normal Power Sense

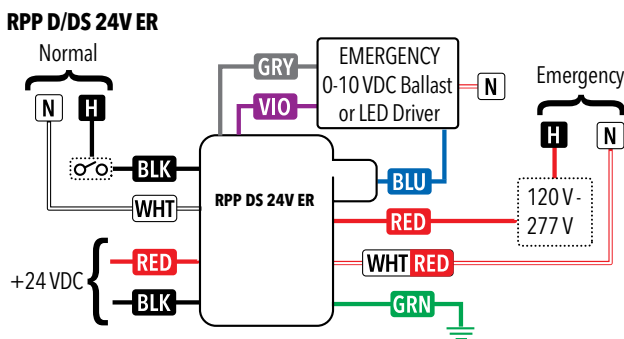

Figure 2

Single Phase with Power Interruption Detection

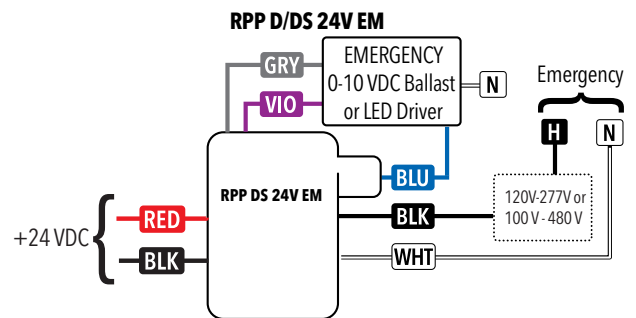

Figure 3

Luminaires with Networked Embedded Controls from nLight

Acuity Brands offers the industry's broadest portfolio of luminaires with networked embedded controls from nLight. Please scan the QR code to see the current luminaires with networked embedded controls from nLight.



Luminaires with Wireless Networked Embedded Controls from nLight



Luminaires with Wired Networked Embedded Controls from nLight

Mobile Apps

Quick and Easy Lighting Configuration and Control In the Palm of Your Hand

nLight Wired



nLight BLE Radio Module

nLight wired uses the nIO BT (Bluetooth® Low Energy radio module) to communicate with the nConfig app to modify the settings and operation of the devices in an nLight zone.

The Bluetooth® word mark and logos are registered trademarks owned by Bluetooth SIG, Inc. and any use of such marks by Acuity Brands Lighting is under license.

nConfig™

The nConfig mobile app is for nLight wired controls startups. It's a quick and easy alternative to SensorView software for smaller projects and simple programming.

nLight AIR



CLAIRITY™ Plus

The CLAIRITY Plus mobile app allows you to start up, configure and troubleshoot nLight AIR wireless controls from a compatible smartphone or tablet.



Additional Resources

Acuity Controls Typical Layout Drawings

<https://www.acuitybrands.com/resources/tools-and-documents/typicals>

Use the Following Sections of the WSEC 2018 Code as Reference:

- Section C405.2.1.1 – Full Auto-Off via Occupancy Sensor
- Section C405.2.1.1.2 – Manual-On or Partial-On
- Section C405.2.1.1.2 – Full Automatic On
- Section C405.2.2 – Programmable Timeclock
- Section C405.2.3 – Manual Control (Local Switch)
- Section C405.2.3.1 – Lighting Reduction Controls
- Section C405.2.4 – Daylight-Responsive Controls
- Section C405.2.6 – Exterior Lighting Controls
- Section C406.4 – Enhanced Digital Lighting Controls

Explore Acuity Academy

Acuity Academy provides educational resources for individuals wanting to expand their lighting, controls and building management technical knowledge. On Acuity Academy, you can register for instructor-led classes, take e-learning courses or watch videos and recorded content. <https://www.acuitybrands.com/resources/training-and-education>

nLight Lighting Controls Platform Page

www.nlightcontrols.com



A+ Certified solutions from Acuity Brands help you quickly and confidently select and implement lighting systems that are both compatible and consistent.

For lighting applications, A+ means verified consistent performance, visual appearance and system interoperability of all luminaires and controls within the certified solutions. For lighting professionals it means confidence that all parts of the lighting system will work together and meet common Acuity Brands specifications.

Go to www.acuitybrands.com/solutions/a-certified or contact your local Acuity Brands representative for more information.

The Bluetooth® word mark and logos are registered trademarks owned by Bluetooth SIG, Inc. and any use of such marks by Acuity Brands Lighting is under license.