



nLight®

Title 24 2022 Applications Guide

www.nlightcontrols.com



Today's nLight® platform is more powerful than ever, providing your environment with innovative networked control that is simple and sophisticated. From simple, convenient, plug-and-play lighting controls to scalable BACnet™/IP-protocol systems, nLight connects a wide range of luminaires, sensors, I/O modules and other digital components to create a smart digital network.

An investment in nLight supports compliance with California's Title 24, Part 6, standards and transforms your space with a fully scalable, connected-building infrastructure that will serve the further needs of your business. Now that is powerful.

/ TABLE OF CONTENTS

- 02 Code Requirement Overview
- 03 How to Use This Guide
- 04 Office Solutions
- 06 Open Plan Office Solutions
- 08 Conference Room Solutions
- 10 Classroom Solutions
- 12 Lobby Solutions
- 14 Corridor Solutions
- 16 Restroom Solutions
- 19 Stairwell Solutions
- 20 Warehouse Storage Solutions
- 21 Gymnasium Solutions
- 22 Parking Garage
- 23 Site Lighting
- 24 nLight Hybrid Networked Lighting Control
- 25 Luminaires with Networked Embedded Controls from nLight
- 26 Requirements Overview

The chart below is an overview of the code requirements for typical building spaces. Please use this information as a guide. For specific code requirements, please refer to the California Code of Regulations, Title 24, Part 6.

	Control Requirement ¹	Code Provision	Code Summary ¹	Space Type								
				Office < 250 sq. ft.	Open Office > 250 sq. ft.	Conference, Meeting Room	Classroom, Lecture Hall, Training Room	Lobby	Corridor	Restroom	Stairwell	
Shut-Off Control	Area Control ²	130.1(a)	All luminaires shall be functionally controlled with manual on and off lighting controls.	✓	✓	✓	✓	✓	✓	✓	✓	✓
	Timeclock	130.1(c) 1	All areas not shut off by occupancy sensing must be shut off by a time switch control when the space is typically unoccupied.		✓			✓	✓	✓	✓	✓
	Automatic Full-Off via Occupancy Sensor ³	130.1(c) 5	Occupant-sensing controls must be used in specific areas to shut off lighting.	✓	(or) ✓ _s	✓	✓	(or) ✓	(or) ✓	(or) ✓	(or) ✓	(or) ✓
	Automatic Partial-Off via Occupancy Sensor ³	130.1(c) 6 & 7	Partial-off occupancy sensing may be used in combination with another form of full automatic shutoff (exception: parking garage areas may use just partial-off sensing).						✓			✓
Light Level Control	Multi-Level Lighting Controls	130.1(b)	Any enclosed area ≥ 100 ft ² with a lighting power density > 0.5 W/ft ² , shall provide multi-level lighting control.	✓	✓	✓	✓	✓			✓	
	Automatic Multi-Level Daylight Controls	130.1(d)	Areas in designated daylight zones with total power ≥ 120 watts use automatic multi-level daylight controls.	✓	✓	✓	✓	✓	✓	✓	✓	✓
Additional Controls	Demand Response	110.12(c), (e) 130.1(e)	Buildings having a total installed lighting power of ≥ 4,000W shall be capable of automatically reducing lighting power, including controlled receptacles in response to demand response signals.	✓	✓	✓	✓	✓	✓	✓	✓	✓
	Receptacle (i.e., Plug Load) Control ⁴	130.5(d)	Both controlled and uncontrolled 120-volt receptacles shall be provided in office areas, lobbies, conference rooms, kitchen areas in office spaces, and copy rooms.	✓	✓	✓		✓				
Outdoor Lighting Controls	Daylight Availability	130.2(c) 1	Lighting shall be controlled by a photo control, astronomical time-switch control or other control to automatically shut off when daylight is available.									
	Automatic Scheduling Controls	130.2(c) 2	Controls shall be capable of reducing the lighting power by 50-90%, and capable of turning the lighting off, during scheduled unoccupied periods. Scheduling a minimum of two nighttime periods with independent lighting levels is required.									
	Motion Sensing Controls	130.2(c) 3	Controls shall be capable of reducing the lighting power by 50-90%, and capable of turning the lighting off, during unoccupied periods. Motion sensing controls shall be capable of reducing the lighting to its dim or off state no longer than 15 minutes after the area has been vacated.									

Gymnasium	Warehouse	Parking Garage	Site Lighting/Facade/Parking Garage Roof
✓	✓	✓	
✓			
	✓	✓	
✓	✓	✓	
✓	✓	✓	
✓	✓	✓	
			✓
			✓
			✓

This Title 24, Part 6, Applications Guide is designed to facilitate quicker and easier lighting controls solutions to help you comply with the requirements of the standards using nLight lighting controls. While there are many ways to design a space to support building energy codes, use this guide as a quick reference to get your project on the path toward compliance. Our Design Services Team is also available to support engineers and contractors with detailed design, submittal, and installation assistance. For additional information, please contact your Acuity Brands sales representative.

Room description

4 Office: < 250 sq. ft., Windows, Luminaires with Networked Embedded Controls from nLight

Wired

Wireless

Legend:
 Use nLight Wires
 Normal Power/Fast

Bill of Materials (Wired)

Symbol	Qty	Product #	Description
[Troffer]	2	See Note	Troffer with Wired Networked Embedded Controls from nLight with Sensor Option
[Switch]	1	nWSXA PDT LV DX	Wall Switch Occupancy Sensor with On/OFF, Raise/Lower
[Relay]	1	nPFD0 PL	Plug Load Relay Pack

Bill of Materials (Wireless)

Symbol	Qty	Product #	Description
[Troffer]	2	See Note	Troffer with Wireless Networked Embedded Controls from nLight with Sensor Option
[Sensor]	1	nPOBBA DX G2	Battery Powered, On/OFF, Raise/Lower, Wall/Food
[Relay]	1	nPFD0 24V EFP G2	Plug Load Relay Pack

OPERATION DETAILS:

Light Fixtures:

- All fixtures are dimmable
- All fixtures can be controlled together or independently
- Maximum level can be set to any percentage via programming

Occupancy Control:

- Partial on occupancy sensors automatically activate between 50-70% of controlled lighting power or fixtures must be turned on manually
- Plug load turns on automatically
- Fixtures and plug load automatically turn off when room becomes vacant

Daylight Control:

- Not required if room has < 241°F of glazing or lighting load < 1,00W on the daylight and the sidelight daylight zone

Manual Control:

- On/off & raise/lower control of fixtures

ADDITIONAL OPTIONS:

- Room can be connected to nLight backbone to enable network control, time scheduling and Automated Demand Response (OpenADR 2.0a)
- HVAC control available through system-wide BACnet® interface option on the ECLYPSE® controller
- Luminaires with wireless networked embedded controls from nLight with occupancy/daylighting sensor options available, please see the fixture specification sheet

Note: Contact your local lighting agent for more information on luminaires with networked embedded controls from nLight.

Room layout diagram with control, fixture, and wiring type detail

List of devices required to implement room layout design above

Additional options that add control capacity beyond code requirements

Operation details describe the functionality provided by the equipment specified in the solution

- Note: This summary is for general information purposes only and is provided without any warranty as to accuracy, completeness, or otherwise. The user should read the applicable code sections for more complete and detailed descriptions of code requirements and exceptions and should consult with a professional engineer or other competent advisor before making any decision or taking any action based on this summary.
- Can be inaccessible to unauthorized personnel
- Not required in residential areas such as hotels, condos or dormitories
- Does not apply to Classrooms and Lecture Halls
- In office spaces greater than 250 square feet, control zones shall not exceed 600 sq ft. Occupancy sensor controls shall be used to reduce light level of vacant zones by 80%, and lighting shall turn off after all control zones are vacant.

Wired

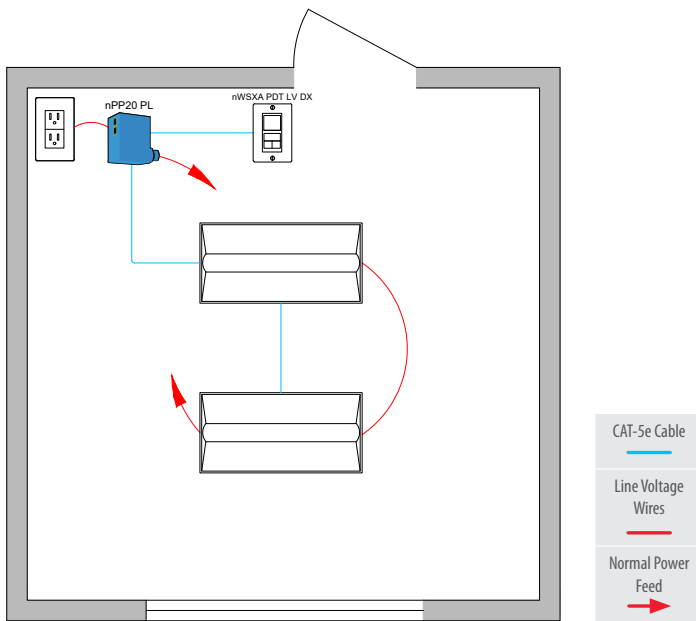

Wireless

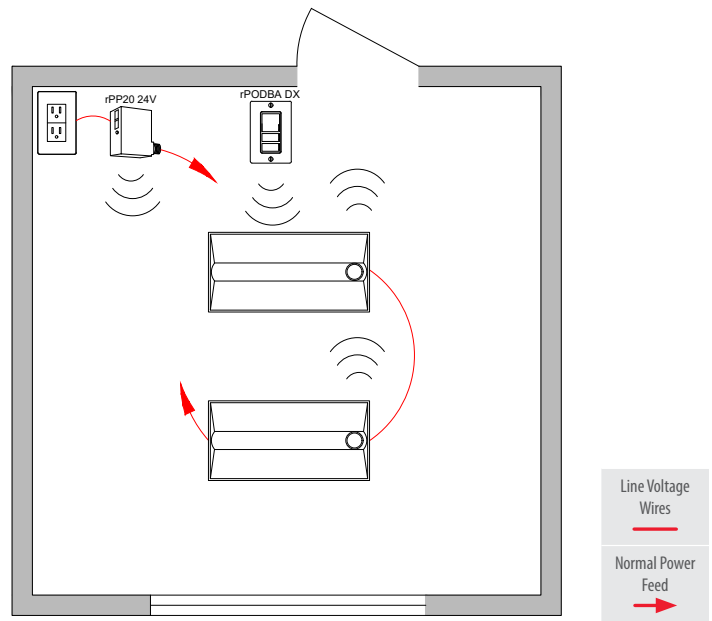

Bill of Materials

Symbol	Qty	Product #	Description
	2	See Note	Troffer with Wired Networked Embedded Controls from nLight with Sensor Option
	1	nWSXA PDT LV DX	Wall Switch Occupancy Sensor with On/Off, Raise/Lower
	1	nPP20 PL	Plug Load Relay Pack

Bill of Materials

Symbol	Qty	Product #	Description
	2	See Note	Troffer with Wireless Networked Embedded Controls from nLight with Sensor Option
	1	rPODBA DX G2	Battery Powered, On/Off, Raise/Lower WallPod
	1	rPP20 24V EFP G2	Plug Load Relay Pack

/ OPERATION DETAILS:

Light Fixtures:

- All fixtures are dimmable
- All fixtures can be controlled together or independently
- Maximum level can be task tuned to any percentage via programming

Occupancy Control:

- Partial-on occupancy sensors automatically activate between 50-70% of controlled lighting power or fixtures must be turned on manually
- Plug load turns on automatically
- Fixtures and plug load automatically turn off when room becomes vacant

Daylight Control:

- Not required if room has < 24 ft² of glazing or lighting load < 120W in the skylit and the sidelit daylight zone

Manual Control:

- On/off & raise/lower control of fixtures

/ ADDITIONAL OPTIONS:

- Room can be connected to nLight backbone to enable network control, time schedules and Automated Demand Response (OpenADR 2.0a)
- HVAC control available through system-wide BACnet® interface option on the ECLYPSE® controller
- Luminaires with wireless networked embedded controls from nLight with occupancy/daylighting sensor options available, please see the fixture specification sheet

Note: Contact your local lighting agent for more information on luminaires with networked embedded controls from nLight.

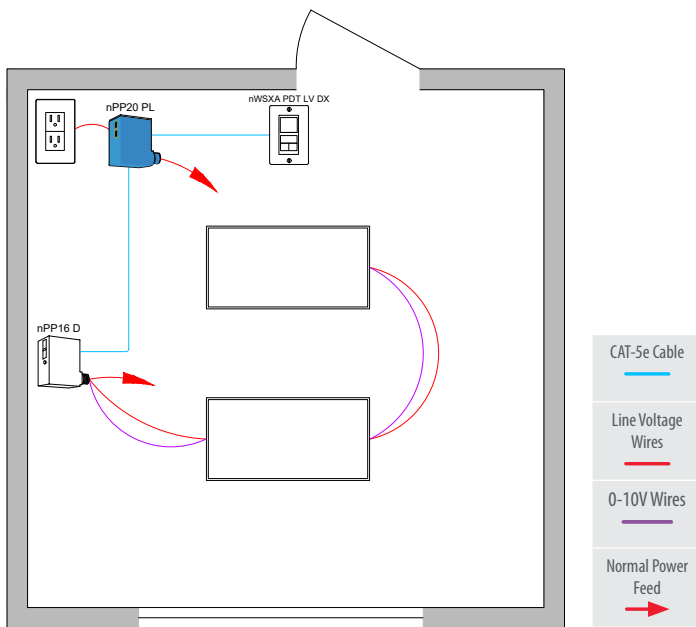

Wired



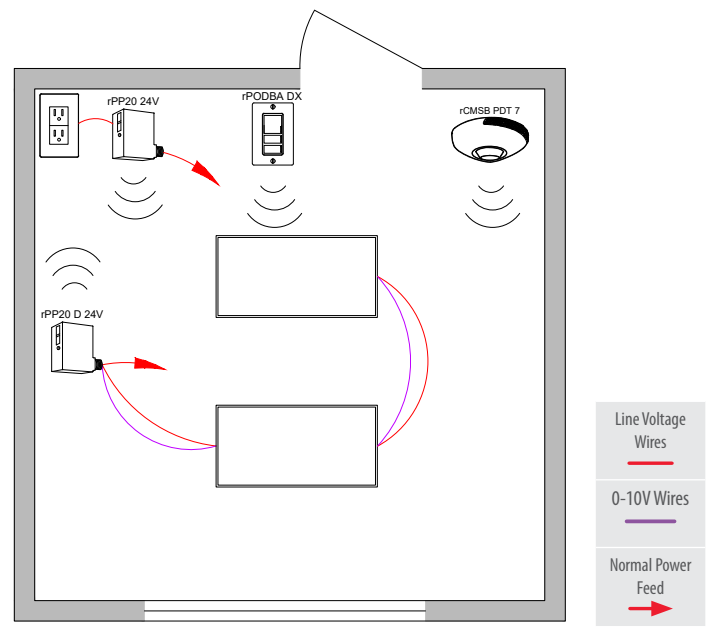



Wireless



Bill of Materials

Symbol	Qty	Product #	Description
	1	nPP16 D EFP	Relay Pack with 0-10V Dimming Output
	1	nWSXA PDT LV DX	Wall Switch Occupancy Sensor with On/Off, Raise/Lower
	1	nPP20 PL	Plug Load Relay Pack

Bill of Materials

Symbol	Qty	Product #	Description
	1	rPP20 D 24V EFP G2	Relay Pack with 0-10V Dimming Output
	1	rPP20 24V EFP G2	Plug Load Relay Pack
	1	rPODBA DX G2	Battery Powered, On/Off, Raise/Lower WallPod
	1	rCMSB PDT 7 G2	Battery Powered Occupancy and Daylight Sensor

/ OPERATION DETAILS:

Light Fixtures:

- All fixtures are dimmable
- Fixtures are controlled based on power pack line voltage and 0-10V wiring
- Maximum level can be task tuned to any percentage via programming

Occupancy Control:

- Partial-on occupancy sensors automatically activate between 50-70% of controlled lighting power or fixtures must be turned on manually
- Plug load turns on automatically
- Fixtures and plug load automatically turn off when room becomes vacant

Daylight Control:

- Not required if room has < 24 ft². of glazing or lighting load < 120W in the skylit and the sidelit daylight zone

Manual Control:

- On/off & raise/lower control of fixtures

/ ADDITIONAL OPTIONS:

- Room can be connected to nLight backbone to enable network control, time schedules and Automated Demand Response (OpenADR 2.0a)
- HVAC control available through system-wide BACnet® interface option on the ECLYPSE controller or through occupancy sensor auxiliary relay (AR) contact option
- Luminaires with wireless networked embedded controls from nLight with occupancy/daylighting sensor options available, please see the fixture specification sheet

Wired

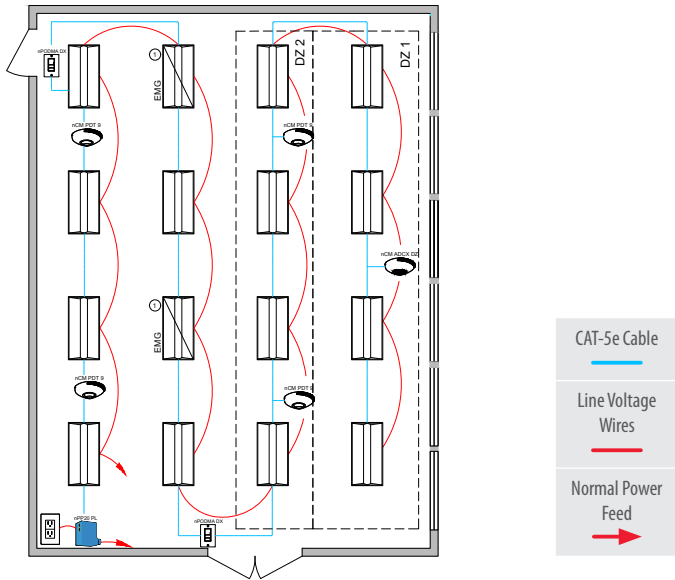

① Some emergency luminaires with networked embedded controls from nLight require separate normal and emergency connections. Wiring shown assumes battery backup emergency option. See fixture spec sheets for options and details.

Wireless

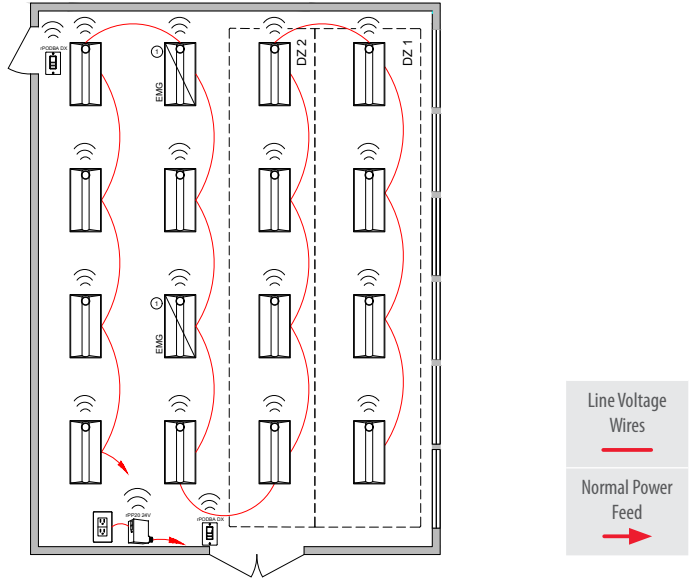

① Some emergency luminaires with networked embedded controls from nLight require separate normal and emergency connections. Wiring shown assumes battery backup emergency option. See fixture spec sheets for options and details.

Bill of Materials

Symbol	Qty	Product #	Description
	14	See Note	Luminaire with Wired Networked Embedded Controls from nLight
	2	See Note	Luminaire with Wired Networked Embedded Controls from nLight with Emergency Option
	2	nPODMA DX	On/Off, Raise/Lower WallPod
	4	nCM PDT 9 RJB	Occupancy Sensor
	1	nCM ADCX DZ RJB	Dual Zone Daylight Sensor
	1	nPP20 PL	Plug Load Relay Pack

/ OPERATION DETAILS:

Light Fixtures:

- All fixtures are dimmable
- All fixtures can be controlled together or independently
- Maximum level can be task tuned to any percentage via programming

Occupancy Control:

- Partial-on occupancy sensors automatically activate between 50-70% of controlled lighting power or fixtures must be turned on manually
- Plug load turns on automatically
- Fixtures and plug load automatically turn off when room becomes vacant
- Each occupancy control zone will not exceed 600 sq ft, will dim to 20% output or less when vacant, and will turn off when all zones are vacant

Daylight Control:

- Not required if room has < 24 ft². of glazing or lighting load < 120W in the skylit and the sidelit daylight zone
- Smooth continuous dimming
- Custom grouping of fixtures into separate daylight zones (max. number of zones = number of fixtures)

Manual Control:

- On/off & raise/lower control of fixtures

/ ADDITIONAL OPTIONS:

- Room can be connected to nLight backbone to enable network control, time schedules and Automated Demand Response (OpenADR 2.0a)
- HVAC control available through system-wide BACnet® interface option on the ECLYPSE® controller
- Luminaires with wireless networked embedded controls from nLight with occupancy/daylighting sensor options available, please see the fixture specification sheet

Note: Contact your local lighting agent for more information on luminaires with networked embedded controls from nLight.

Wired

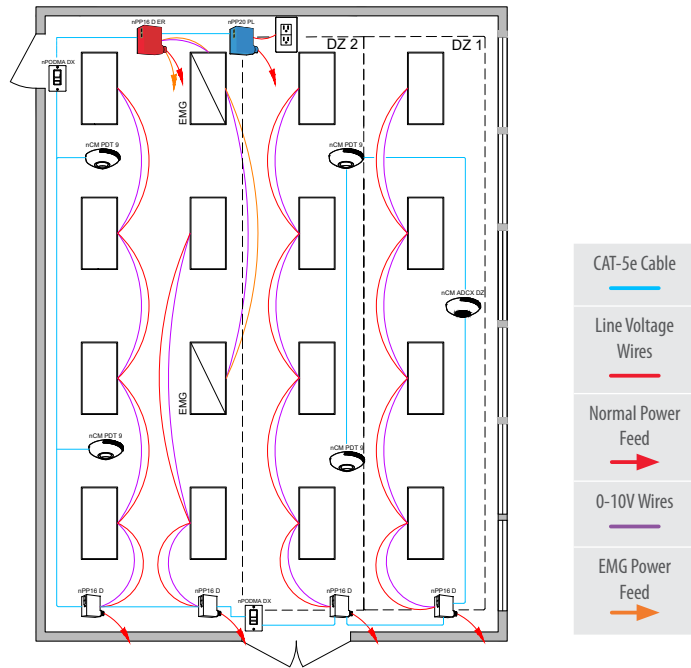

Wireless

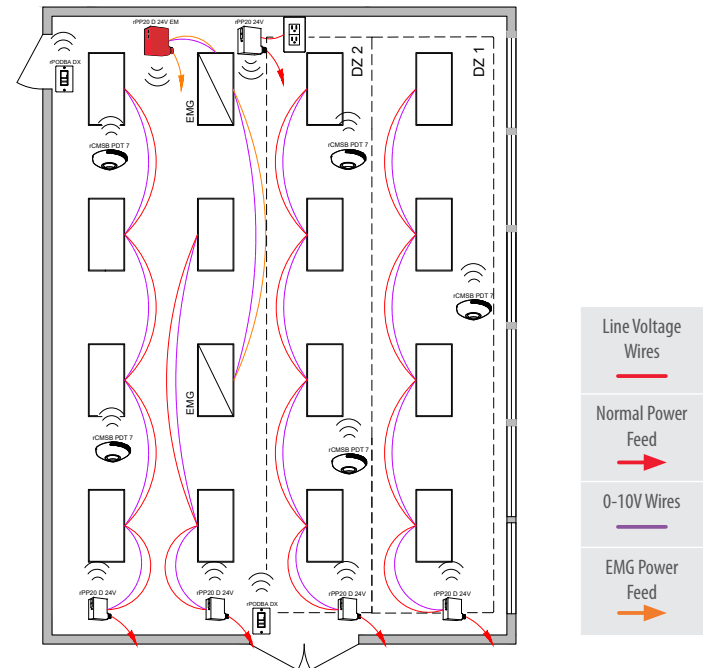

① nLight AIR devices with an EM option must be grouped with a normal power sensing device to exit emergency operation. See control device spec sheet for details.

Bill of Materials

Symbol	Qty	Product #	Description
	4	nPP16 D EFP	Relay Pack with 0-10V Dimming Output
	1	nPP16 D ER EFP	Emergency Relay Pack with 0-10V Dimming Output
	2	nPODMA DX	On/Off, Raise/Lower WallPod
	4	nCM PDT 9 RJB	Occupancy Sensor
	1	nCM ADCX DZ RJB	Dual Zone Daylight Sensor
	1	nPP20 PL	Plug Load Relay Pack

/ OPERATION DETAILS:

Light Fixtures:

- All fixtures are dimmable
- Fixtures are controlled based on power pack line voltage and 0-10V wiring
- Maximum level can be task tuned to any percentage via programming

Occupancy Control:

- Partial-on occupancy sensors automatically activate between 50-70% of controlled lighting power or fixtures must be tuned on manually
- Plug load turns on automatically
- Fixtures and plug load automatically turn off when room becomes vacant
- Each occupancy control zone will not exceed 600 sq ft, will dim to 20% output or less when vacant, and will turn off when all zones are vacant

Daylight Control:

- Not required if room has < 24 ft². of glazing or lighting load < 120W in the skylit and the sidelit daylight zone
- Smooth continuous dimming
- Daylight zones defined by relay packs

Manual Control:

- On/off & raise/lower control of fixtures

Bill of Materials

Symbol	Qty	Product #	Description
	4	rPP20 D 24V EFP G2	Relay Pack with 0-10V Dimming Output
	1	rPP20 D 24V EM EFP G2	Emergency Relay Pack with 0-10V Dimming Output
	2	rPODBA DX G2	Battery Powered, On/Off, Raise/Lower WallPod
	5	rCMSB PDT 7 G2	Battery Powered Occupancy and Daylight Sensor
	1	rPP20 24V EFP G2	Plug Load Relay Pack

/ ADDITIONAL OPTIONS:

- Room can be connected to nLight backbone to enable network control, time schedules and Automated Demand Response (OpenADR 2.0a)
- HVAC control available through system-wide BACnet® interface option on the ECLYPSE controller or through occupancy sensor auxiliary relay (AR) contact option
- Luminaires with wireless networked embedded controls from nLight with occupancy/daylighting sensor options available, please see the fixture specification sheet

Wired

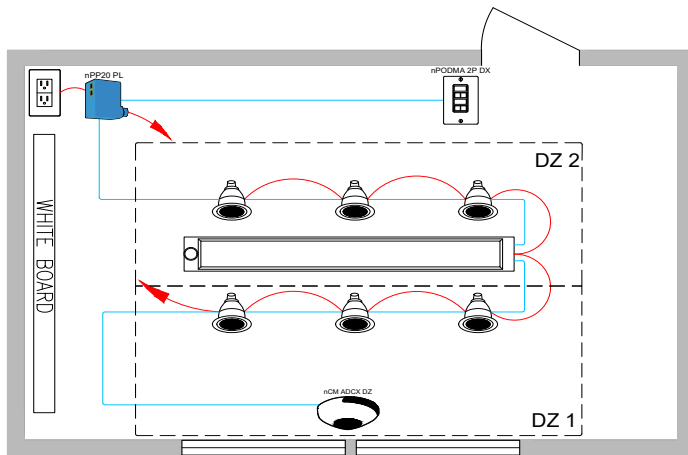

CAT-5e Cable

Line Voltage Wires

Normal Power Feed

Wireless

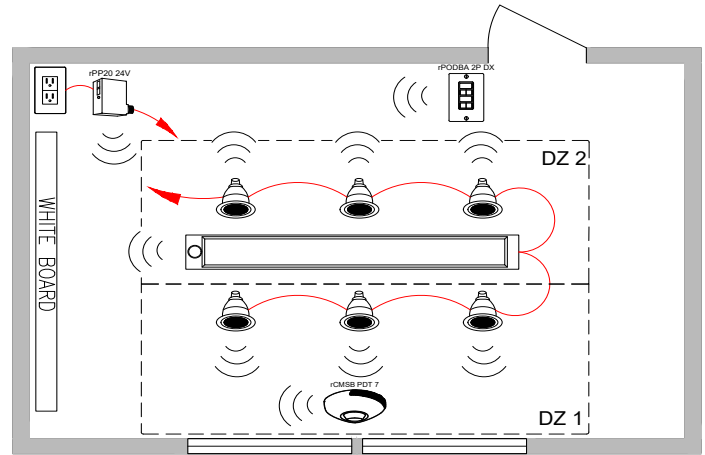

Line Voltage Wires

Normal Power Feed

Bill of Materials

Symbol	Qty	Product #	Description
	1	See Note	Luminaire with Wired Networked Embedded Controls from nLight with Sensor Option
	6	See Note	Downlight with Wired Networked Embedded Controls from nLight
	1	nPODMA 2P DX	2-Pole, On/Off, Raise/Lower WallPod
	1	nPP20 PL	Plug Load Relay Pack
	1	nCM ADCX DZ RJB	Dual Zone Daylight Sensor

Bill of Materials

Symbol	Qty	Product #	Description
	1	See Note	Luminaire with Wireless Networked Embedded Controls from nLight with Sensor Option
	6	See Note	Downlight with Wireless Networked Embedded Controls from nLight
	1	rPODBA 2P DX G2	Battery Powered, 2-Pole, On/Off, Raise/Lower WallPod
	1	rPP20 24V EFP G2	Plug Load Relay Pack
	1	rCMSB PDT 7 G2	Battery Powered Occupancy and Daylight Sensor

/ OPERATION DETAILS:

Light Fixtures:

- All fixtures are dimmable
- All fixtures can be controlled together or independently
- Maximum level can be task tuned to any percentage via programming

Occupancy Control:

- Partial-on occupancy sensors automatically activate between 50-70% of controlled lighting power or fixtures must be turned on manually
- Plug load turns on automatically
- Fixtures and plug load automatically turn off when room becomes vacant

Daylight Control:

- Not required if room has < 24 ft² of glazing or lighting load < 120W in the skylit and the sidelit daylight zone
- Smooth continuous dimming
- Custom grouping of fixtures into separate daylight zones (max. number of zones = number of fixtures)

Manual Control:

- On/off & raise lower control of two zones of fixtures

/ ADDITIONAL OPTIONS:

- Room can be connected to nLight backbone to enable network control, time schedules and Automated Demand Response (OpenADR 2.0a)
- HVAC control available through system-wide BACnet® interface option on the ECLYPSE® controller
- Luminaires with wireless networked embedded controls from nLight with occupancy/daylighting sensor options available, please see the fixture specification sheet

Note: Contact your local lighting agent for more information on luminaires with networked embedded controls from nLight.

Wired

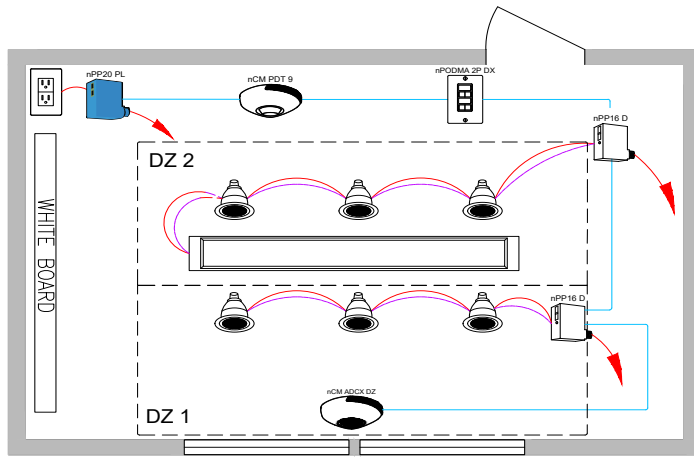

Wireless

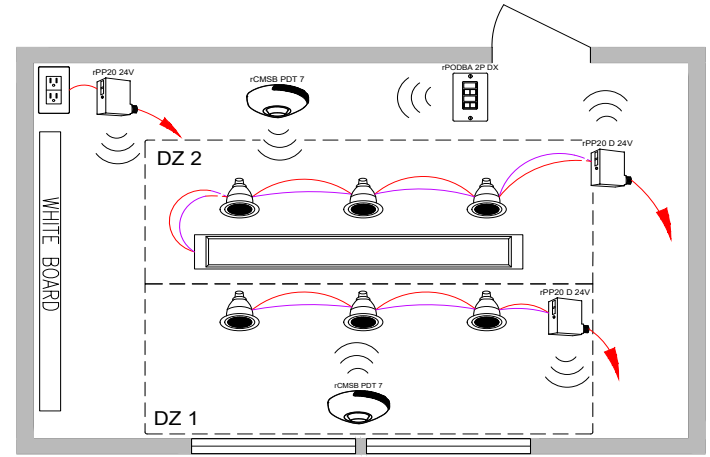

Bill of Materials

Symbol	Qty	Product #	Description
	2	nPP16 D EFP	Relay Pack with 0-10V Dimming Output
	1	nPODMA 2P DX	2-Pole, On/Off, Raise/Lower WallPod
	1	nCM PDT 9 RJB	Occupancy Sensor
	1	nCM ADCX DZ RJB	Dual Zone Daylight Sensor
	1	nPP20 PL	Plug Load Relay Pack

Bill of Materials

Symbol	Qty	Product #	Description
	2	rPP20 D 24V EFP G2	Relay Pack with 0-10V Dimming Output
	1	rPODBA 2P DX G2	Battery Powered, 2-Pole, On/Off, Raise/Lower WallPod
	2	rCMSB PDT 7 G2	Battery Powered Occupancy and Daylight Sensor
	1	rPP20 24V EFP G2	Plug Load Relay Pack

OPERATION DETAILS:

Light Fixtures:

- All fixtures are dimmable
- Fixtures are controlled based on power pack line voltage and 0-10V wiring
- Maximum level can be task tuned to any percentage via programming

Occupancy Control:

- Partial-on occupancy sensors automatically activate between 50-70% of controlled lighting power or fixtures must be turned on manually
- Plug load turns on automatically
- Fixtures and plug load automatically turn off when room becomes vacant

Daylight Control:

- Not required if room has < 24 ft². of glazing or lighting load < 120W in the skylit and the sidelit daylight zone
- Smooth continuous dimming
- Daylight zones defined by relay packs

Manual Control:

- On/off & raise lower control of two zones of fixtures

ADDITIONAL OPTIONS:

- Room can be connected to nLight backbone to enable network control, time schedules and Automated Demand Response (OpenADR 2.0a)
- HVAC control available through system-wide BACnet® interface option on the ECLYPSE controller or through occupancy sensor auxiliary relay (AR) contact option
- Luminaires with wireless networked embedded controls from nLight with occupancy/daylighting sensor options available, please see the fixture specification sheet

Wired

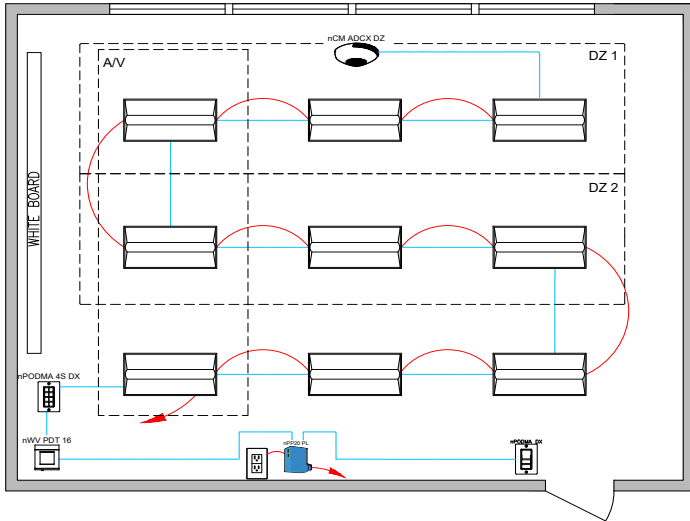

Wireless

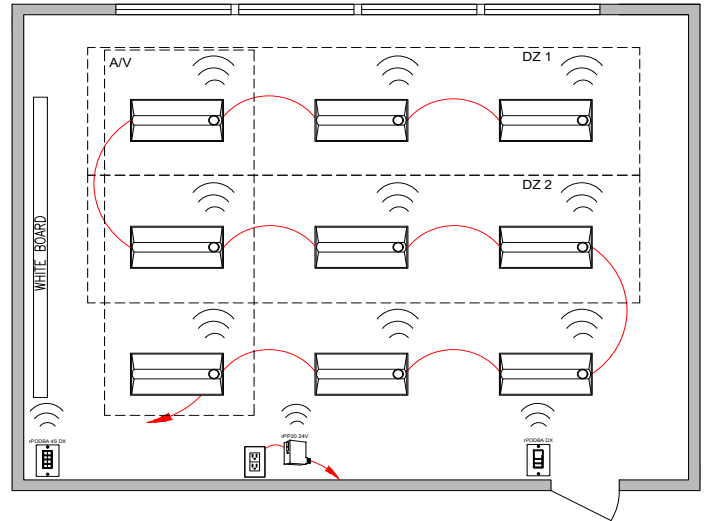

Bill of Materials

Symbol	Qty	Product #	Description
	9	See Note	Troffer with Wired Networked Embedded Controls from nLight
	1	nPODMA DX	On/Off, Raise/Lower WallPod
	1	nPP20 PL	Plug Load Relay Pack
	1	nPODMA 4S DX	Teacher Station — 4 Scene Control with Master On/Off & Raise/Lower
	1	nWV PDT 16	Dual Technology Wide View Occupancy Sensor
	1	nCM ADCX DZ RJB	Dual Zone Daylight Sensor

Bill of Materials

Symbol	Qty	Product #	Description
	9	See Note	Troffer with Wireless Networked Embedded Controls from nLight with Sensor Option
	1	rPODBA DX G2	Battery Powered, On/Off, Raise/Lower WallPod
	1	rPODBA 4S DX G2	Teacher Station — Battery Powered 4 Scene Control with Master On/Off & Raise/Lower
	1	rPP20 24V EFP G2	Plug Load Relay Pack

/ OPERATION DETAILS:

Light Fixtures:

- All fixtures are dimmable
- All fixtures can be controlled together or independently
- Maximum level can be task tuned to any percentage via programming

Occupancy Control:

- Partial-on occupancy sensors automatically activate between 50-70% of controlled lighting power or fixtures must be turned on manually
- Fixture automatically turn off when room becomes vacant

Daylight Control:

- Not required if room has < 24 ft². of glazing or lighting load < 120W in the skylit and the sidelit daylight zone
- Smooth continuous dimming
- Custom grouping of fixtures into separate daylight zones (max. number of zones = number of fixtures)

Manual Control:

- On/off & raise/lower control of fixtures
- Teacher station with 4 preset scenes

/ ADDITIONAL OPTIONS:

- Room can be connected to nLight backbone to enable network control, time schedules and Automated Demand Response (OpenADR 2.0a)
- HVAC control available through system-wide BACnet® interface option on the ECLYPSE® controller
- Luminaires with wireless networked embedded controls from nLight with occupancy/daylighting sensor options available, please see the fixture specification sheet

Note: Contact your local lighting agent for more information on luminaires with networked embedded controls from nLight.

Wired

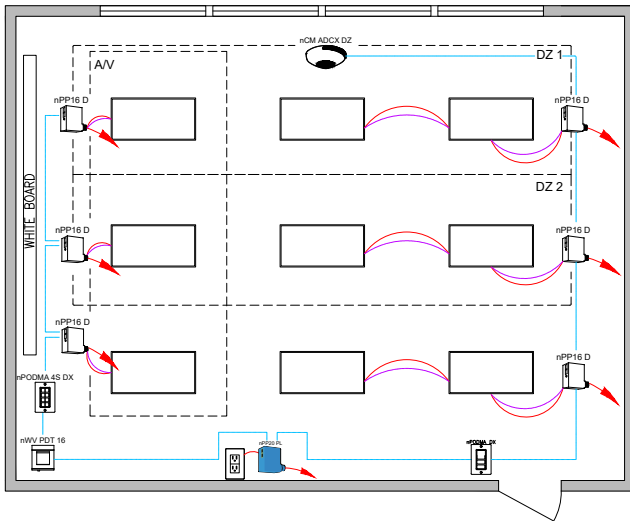

Wireless

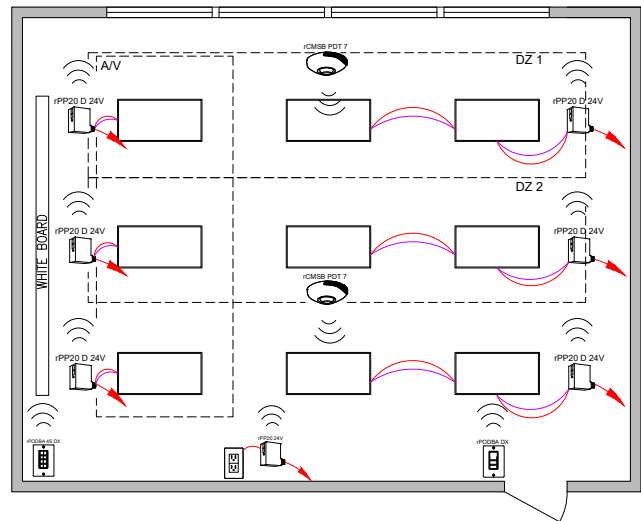

Bill of Materials

Symbol	Qty	Product #	Description
	6	nPP16 D EFP	Relay Module with 0-10V Dimming Output
	1	nPODMA DX	On/Off, Raise/Lower WallPod
	1	nWV PDT 16	Dual Technology Wide View Occupancy Sensor
	1	nPODMA 4S DX	Teacher Station — 4 Scene Control with Master On/Off & Raise/Lower
	1	nCM ADCX DZ RJB	Dual Zone Daylight Sensor
	1	nPP20 PL	Plug Load Relay Pack

Bill of Materials

Symbol	Qty	Product #	Description
	6	rPP20 D 24V EFP G2	Relay Pack with 0-10V Dimming Output
	1	rPODBA DX G2	Battery Powered, On/Off, Raise/Lower WallPod
	2	rCMSB PDT 7 G2	Battery Powered Occupancy and Daylight Sensor
	1	rPODBA 4S DX G2	Teacher Station — Battery Powered 4 Scene Control with Master On/Off & Raise/Lower
	1	rPP20 24V EFP G2	Plug Load Relay Pack

/ OPERATION DETAILS:

Light Fixtures:

- All fixtures are dimmable
- Fixtures are controlled based on power pack line voltage and 0-10V wiring
- Maximum level can be task tuned to any percentage via programming

Occupancy Control:

- Partial-on occupancy sensors automatically activate between 50-70% of controlled lighting power or fixtures must be turned on manually
- Fixture automatically turn off when room becomes vacant

Daylight Control:

- Not required if room has < 24 ft². of glazing or lighting load < 120W in the skylit and the sidelit daylight zone
- Smooth continuous dimming
- Daylight zones defined by relay packs

Manual Control:

- On/off & raise/lower control of fixtures
- Teacher station with 4 preset scenes

/ ADDITIONAL OPTIONS:

- Room can be connected to nLight backbone to enable network control, time schedules and Automated Demand Response (OpenADR 2.0a)
- HVAC control available through system-wide BACnet® interface option on the ECLYPSE controller or through occupancy sensor auxiliary relay (AR) contact option
- Luminaires with wireless networked embedded controls from nLight with occupancy/daylighting sensor options available, please see the fixture specification sheet

Wired

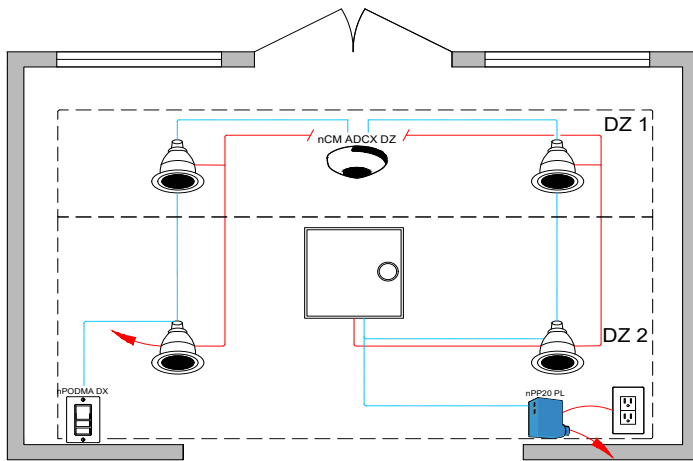

Wireless

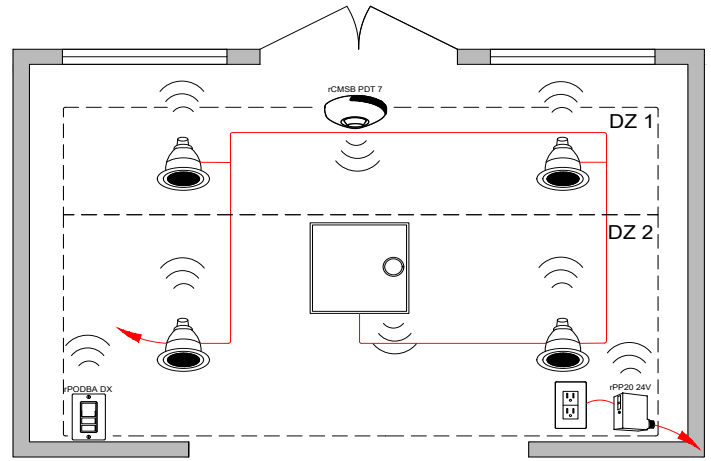

Bill of Materials

Symbol	Qty	Product #	Description
	4	See Notes	Downlight with Wired Networked Embedded Controls from nLight
	1	See Notes	Troffer with Wired Networked Embedded Controls from nLight with Sensor Option
	1	nPODMA DX	On/Off, Raise/Lower WallPod
	1	nPP20 PL	Plug Load Relay Pack
	1	nCM ADCX DZ RJB	Dual Zone Daylight Sensor

Bill of Materials

Symbol	Qty	Product #	Description
	4	See Notes	Downlight with Wireless Networked Embedded Controls from nLight
	1	See Notes	Troffer with Wireless Networked Embedded Controls from nLight with Sensor Option
	1	rPODBA DX G2	Battery Powered, On/Off, Raise/Lower WallPod
	1	rPP20 24V G2	Plug Load Relay Pack
	1	rCMSB PDT 7 G2	Battery Powered Occupancy and Daylight Sensor

/ OPERATION DETAILS:

Light Fixtures:

- All fixtures are dimmable
- All fixtures can be controlled together or independently
- Maximum level can be task tuned to any percentage via programming

Occupancy Control:

- Partial-on occupancy sensors automatically activate between 50-70% of controlled lighting power or fixtures must be turned on manually
- Plug load turns on automatically
- Fixtures and plug load automatically turn off when room becomes vacant

Daylight Control:

- Not required if room has < 24 ft² of glazing or lighting load < 120W in the skylit and the sidelit daylight zone
- Smooth continuous dimming
- Custom grouping of fixtures into separate daylight zones (max. number of zones = number of fixtures)

Manual Control:

- On/off & raise/lower control of fixtures

/ ADDITIONAL OPTIONS:

- Room can be connected to nLight backbone to enable network control, time schedules and Automated Demand Response (OpenADR 2.0a)
- HVAC control available through system-wide BACnet® interface option on the ECLYPSE® controller
- Luminaires with wireless networked embedded controls from nLight with occupancy/daylighting sensor options available, please see the fixture specification sheet

Note: Contact your local lighting agent for more information on luminaires with networked embedded controls from nLight.

Wired

Wireless

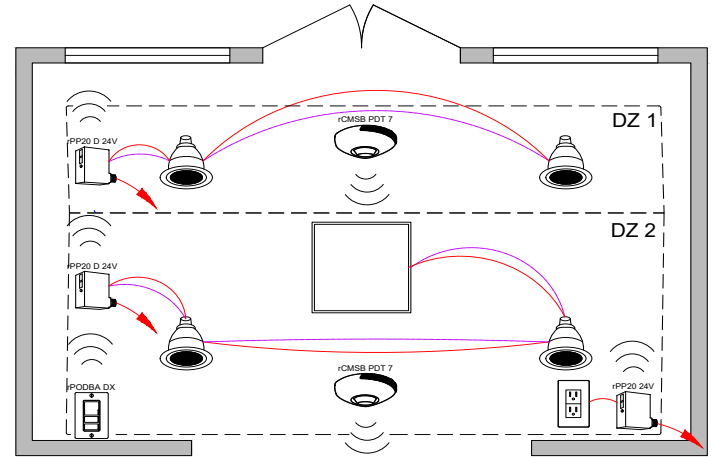
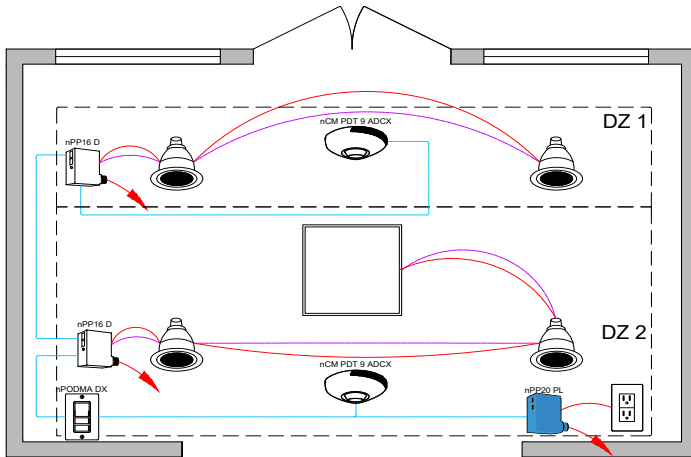

Bill of Materials

Symbol	Qty	Product #	Description
	2	nPP16 D EFP	Relay Pack with 0-10V Dimming Output
	1	nPODMA DX	On/Off, Raise/Lower WallPod
	2	nCM PDT 9 ADCX	Occupancy and Daylight Sensor
	1	nPP20 PL	Plug Load Relay Pack

Bill of Materials

Symbol	Qty	Product #	Description
	2	rPP20 D 24V EFP G2	Relay Pack with 0-10V Dimming Output
	1	rPODBA DX G2	Battery Powered, On/Off, Raise/Lower WallPod
	2	rCMSB PDT 7 G2	Battery Powered Occupancy and Daylight Sensor
	1	rPP20 24V G2	Plug Load Relay Pack

/ OPERATION DETAILS:

Light Fixtures:

- All fixtures are dimmable
- Fixtures are controlled based on power pack line voltage and 0-10V wiring
- Maximum level can be task tuned to any percentage via programming

Occupancy Control:

- Partial-on occupancy sensors automatically activate between 50-70% of controlled lighting power or fixtures must be turned on manually
- Plug load turns on automatically
- Fixtures and plug load automatically turn off when room becomes vacant

Daylight Control:

- Not required if room has < 24 ft². of glazing or lighting load < 120W in the skylit and the sidelit daylight zone
- Smooth continuous dimming
- Daylight zones defined by relay packs

Manual Control:

- On/off & raise/lower control of fixtures

/ ADDITIONAL OPTIONS:

- Room can be connected to nLight backbone to enable network control, time schedules and Automated Demand Response (OpenADR 2.0a)
- HVAC control available through system-wide BACnet® interface option on the ECLYPSE controller or through occupancy sensor auxiliary relay (AR) contact option
- Luminaires with wireless networked embedded controls from nLight with occupancy/daylighting sensor options available, please see the fixture specification sheet

Wired

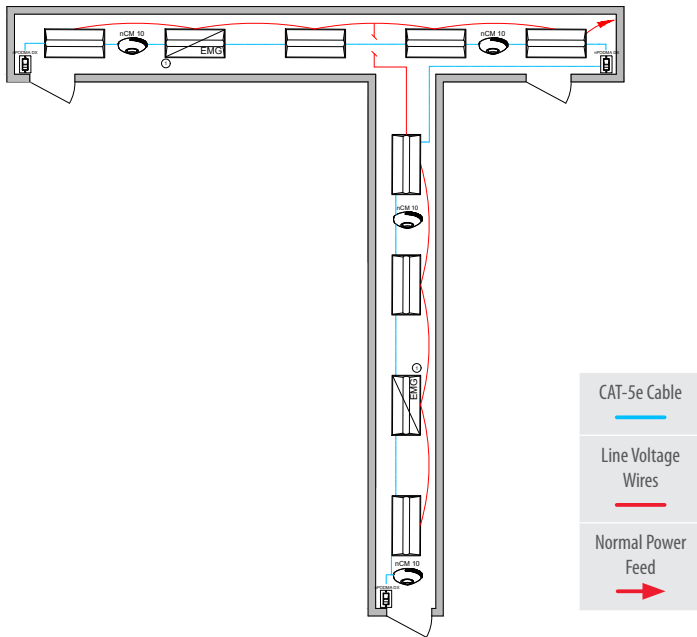

① Some emergency luminaires with networked embedded controls from nLight require separate normal and emergency connections. Wiring shown assumes battery backup emergency option. See fixture spec sheets for options and details.

Wireless

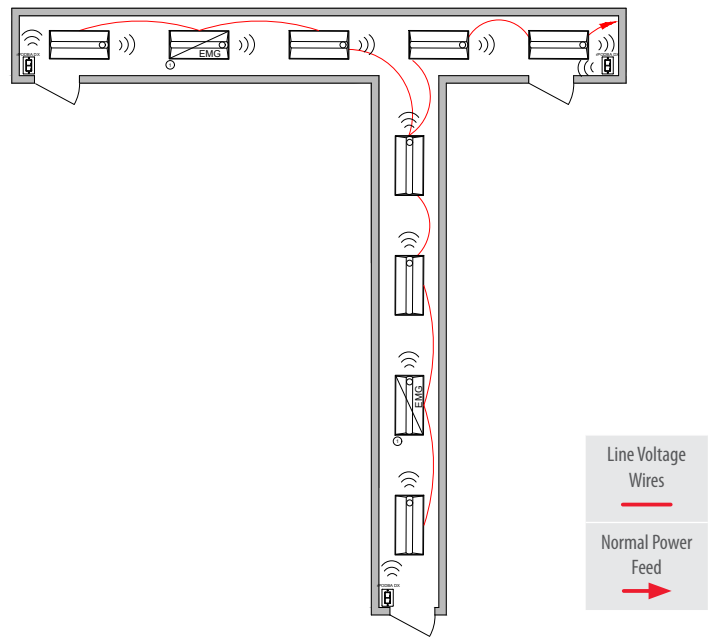

① Some emergency luminaires with wireless networked embedded controls from nLight require separate normal and emergency connections. Wiring shown assumes battery backup emergency option. See fixture spec sheets for options and details.

Bill of Materials

Symbol	Qty	Product #	Description
	7	See Note	Troffer with Wired Networked Embedded Controls from nLight
	2	See Note	Troffer with Wired Networked Embedded Controls from nLight with Battery Option
	4	nCM 10 RJB	Occupancy Sensor
	3	nPODMA DX	On/Off, Raise/Lower WallPod

Bill of Materials

Symbol	Qty	Product #	Description
	7	See Note	Troffer with Wireless Networked Embedded Controls from nLight with Sensor Option
	2	See Note	Troffer with Wireless Networked Embedded Controls from nLight with Battery Option
	3	rPODBA DX G2	Battery Powered, On/Off, Raise/Lower WallPod

/ OPERATION DETAILS:

Light Fixtures:

- All fixtures are dimmable
- All fixtures can be controlled together or independently
- Maximum level can be task tuned to any percentage via programming

Occupancy Control:

- Fixtures automatically turn off or optionally can be configured to drop to low dim setting of at least 50% when space becomes vacant

Daylight Control:

- Not required if room has < 24 ft². of glazing or lighting load < 120W in the skylit and the sidelit daylight zone
- Smooth continuous dimming
- Custom grouping of fixtures into separate daylight zones (max. number of zones = number of fixtures)

Manual Control:

- On/off & raise/lower control of fixtures

/ ADDITIONAL OPTIONS:

- Room can be connected to nLight backbone to enable network control, time schedules and Automated Demand Response (OpenADR 2.0a)
- HVAC control available through system-wide BACnet® interface option on the ECLYPSE® controller
- Luminaires with wireless networked embedded controls from nLight with occupancy/daylighting sensor options available, please see the fixture specification sheet

Note: Contact your local lighting agent for more information on luminaires with networked embedded controls from nLight.

Wired

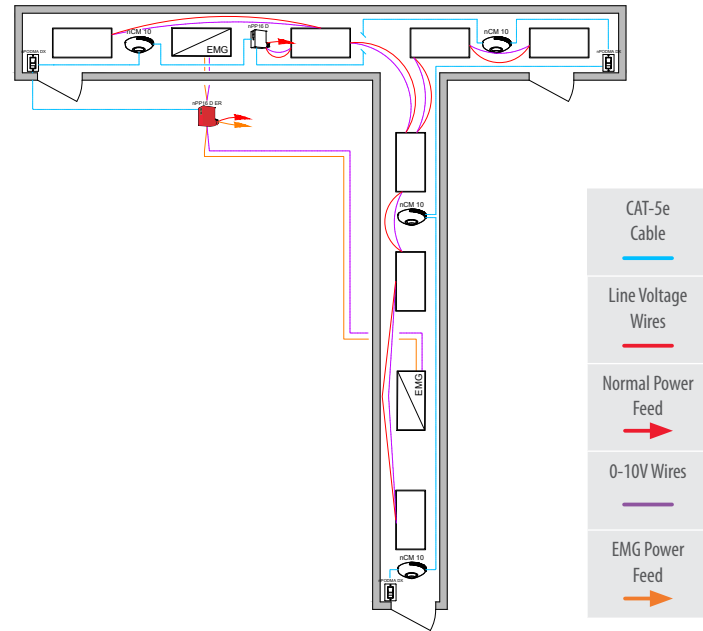

Wireless

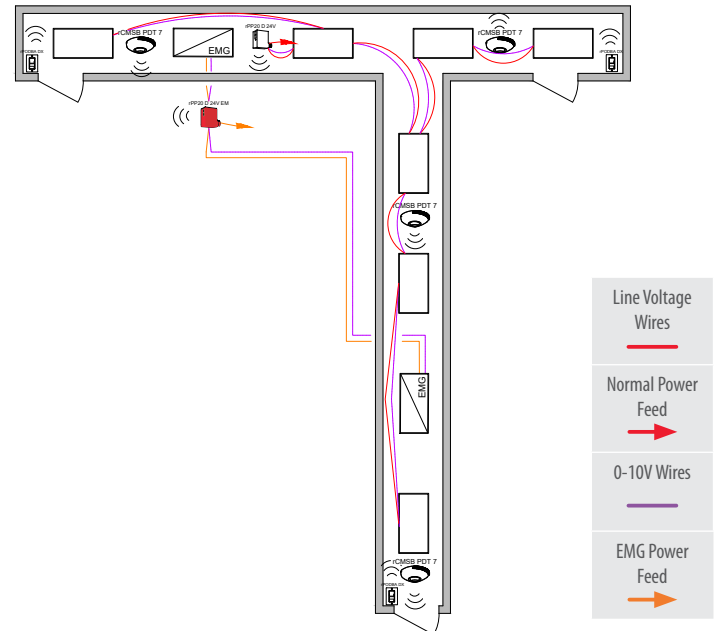

① nLight AIR devices with an EM option must be grouped with a normal power sensing device to exit emergency operation. See control device spec sheet for details.

Bill of Materials

Symbol	Qty	Product #	Description
	1	nPP16 D EFP	Relay Pack with 0-10V Dimming Output
	1	nPP16 D ER EFP	Emergency Relay Pack with 0-10V Dimming Output
	4	nCM 10 RJB	Occupancy Sensor
	3	nPODMA DX	On/Off, Raise/Lower WallPod

Bill of Materials

Symbol	Qty	Product #	Description
	1	rPP20 D 24V EFP G2	Relay Pack with 0-10V Dimming Output
	1	rPP20 D 24V EM EFP G2	Emergency Relay Pack with 0-10V Dimming Output
	4	rCMSB PDT 7 G2	Battery Powered Occupancy Sensor
	3	rPODBA DX G2	Battery Powered, On/Off, Raise/Lower WallPod

/ OPERATION DETAILS:

Light Fixtures:

- All fixtures are dimmable
- Fixtures are controlled based on power pack line voltage and 0-10V wiring
- Maximum level can be task tuned to any percentage via programming

Occupancy Control:

- Fixtures automatically turn off or optionally can be configured to drop to low dim setting of at least 50% when space becomes vacant

Daylight Control:

- Not required if room has < 24 ft². of glazing or lighting load < 120W in the skylit and the sidelit daylight zone
- Smooth continuous dimming
- Daylight zones defined by relay packs

Manual Control:

- On/off & raise/lower control of fixtures

/ ADDITIONAL OPTIONS:

- Room can be connected to nLight backbone to enable network control, time schedules and Automated Demand Response (OpenADR 2.0a)
- HVAC control available through system-wide BACnet® interface option on the ECLYPSE controller or through occupancy sensor auxiliary relay (AR) contact option
- Luminaires with wireless networked embedded controls from nLight with occupancy/daylighting sensor options available, please see the fixture specification sheet

Wired

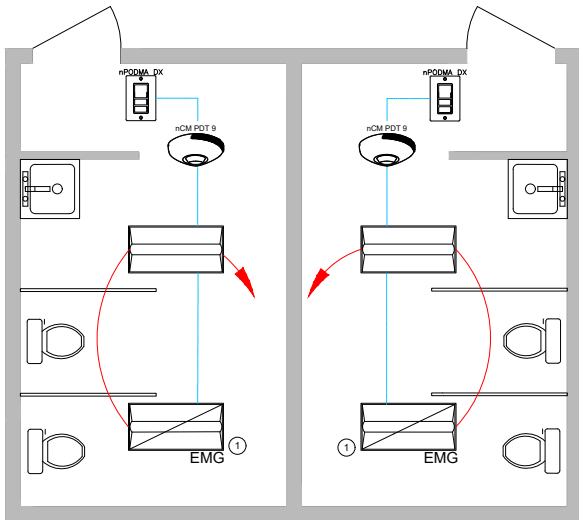

① Some emergency luminaires with networked embedded controls from nLight require separate normal and emergency connections. Wiring shown assumes battery backup emergency option. See fixture spec sheets for options and details.



Wireless

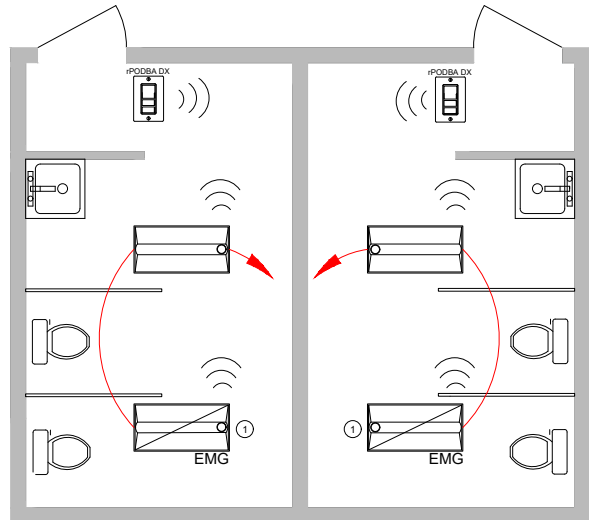

① Some emergency luminaires with wireless networked embedded controls from nLight require separate normal and emergency connections. Wiring shown assumes battery backup emergency option. See fixture spec sheets for options and details.



Bill of Materials

Symbol	Qty	Product #	Description
	2	See Note	Troffer with Wired Networked Embedded Controls from nLight
	2	See Note	Troffer with Wired Networked Embedded Controls from nLight with Battery Option
	2	nCM PDT 9 RJB	Occupancy Sensor
	2	nPODMA DX	On/Off, Raise/Lower WallPod

Bill of Materials

Symbol	Qty	Product #	Description
	2	See Note	Troffer with Wireless Networked Embedded Controls from nLight with Sensor Option
	2	See Note	Troffer with Wireless Networked Embedded Controls from nLight with Battery Option
	2	rPODBA DX G2	Battery Powered, On/Off, Raise/Lower WallPod

/ OPERATION DETAILS:

Light Fixtures:

- All fixtures are dimmable
- All fixtures can be controlled together or independently
- Maximum level can be task tuned to any percentage via programming

Occupancy Control:

- Partial-on occupancy sensors automatically activate between 50-70% of controlled lighting power or fixtures must be turned on manually
- Fixture automatically turn off when room becomes vacant

Daylight Control:

- Not required if room has < 24 ft² of glazing or lighting load < 120W in the skylit and the sidelit daylight zone
- Smooth continuous dimming
- Custom grouping of fixtures into separate daylight zones (max. number of zones = number of fixtures)

Manual Control:

- On/off & raise/lower control of fixtures

/ ADDITIONAL OPTIONS:

- Room can be connected to nLight backbone to enable network control, time schedules and Automated Demand Response (OpenADR 2.0a)
- HVAC control available through system-wide BACnet® interface option on the ECLYPSE® controller
- Luminaires with wireless networked embedded controls from nLight with occupancy/daylighting sensor options available, please see the fixture specification sheet

Note: Contact your local lighting agent for more information on luminaires with networked embedded controls from nLight.

Wired

Wireless

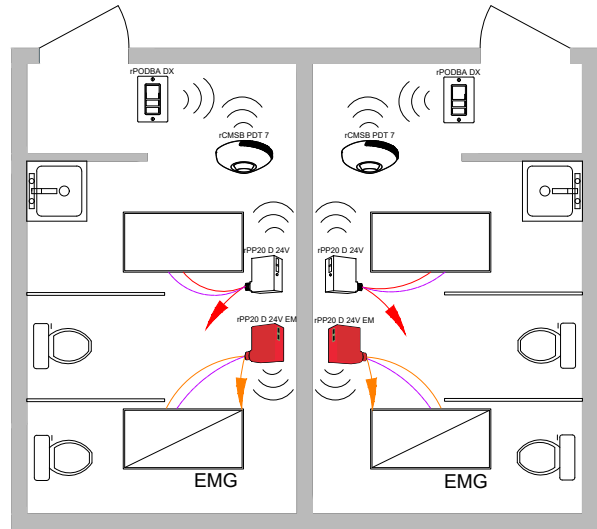
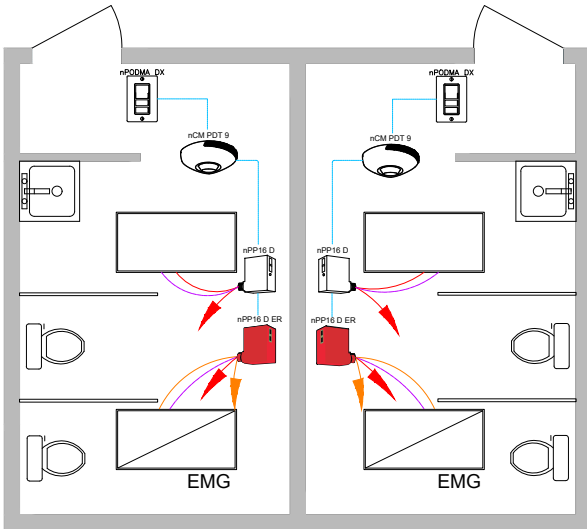

① nLight AIR devices with an EM option must be grouped with a normal power sensing device to exit emergency operation. See control device spec sheet for details.



Bill of Materials

Symbol	Qty	Product #	Description
	2	nPP16 D EFP	Relay Pack with 0-10V Dimming Output
	2	nPP16 D ER EFP	Emergency Module with 0-10V Dimming Output
	2	nCM PDT 9 RJB	Occupancy Sensor
	2	nPODMA DX	On/Off, Raise/Lower WallPod

Bill of Materials

Symbol	Qty	Product #	Description
	2	rPP20 D 24V EFP G2	Relay Pack with 0-10V Dimming Output
	2	rPP20 D 24V EM EFP G2	Emergency Relay Pack with 0-10V Dimming Output
	2	rCMSB PDT 7 G2	Battery Powered Occupancy Sensor
	2	rPODBA DX G2	Battery Powered, On/Off, Raise/Lower WallPod

/ OPERATION DETAILS:

Light Fixtures:

- All fixtures are dimmable
- Fixtures are controlled based on power pack line voltage and 0-10V wiring
- Maximum level can be task tuned to any percentage via programming

Occupancy Control:

- Partial-on occupancy sensors automatically activate between 50-70% of controlled lighting power or fixtures must be turned on manually
- Fixture automatically turn off when room becomes vacant

Daylight Control:

- Not required if room has < 24 ft². of glazing or lighting load < 120W in the skylit and the sidelit daylight zone
- Smooth continuous dimming
- Daylight zones defined by relay packs

Manual Control:

- On/off & raise/lower control of fixtures

/ ADDITIONAL OPTIONS:

- Room can be connected to nLight backbone to enable network control, time schedules and Automated Demand Response (OpenADR 2.0a)
- HVAC control available through system-wide BACnet® interface option on the ECLYPSE controller or through occupancy sensor auxiliary relay (AR) contact option
- Luminaires with wireless networked embedded controls from nLight with occupancy/daylighting sensor options available, please see the fixture specification sheet

Wired

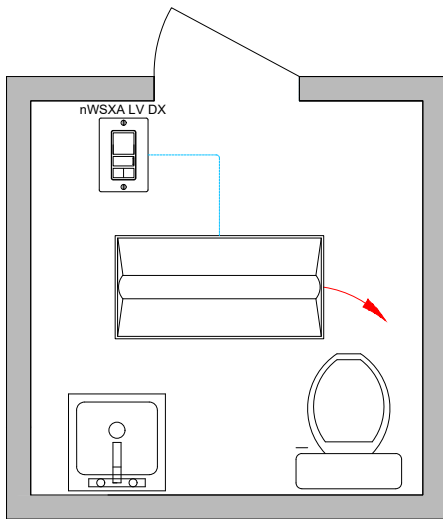

CAT-5e Cable

Line Voltage Wires

Normal Power Feed

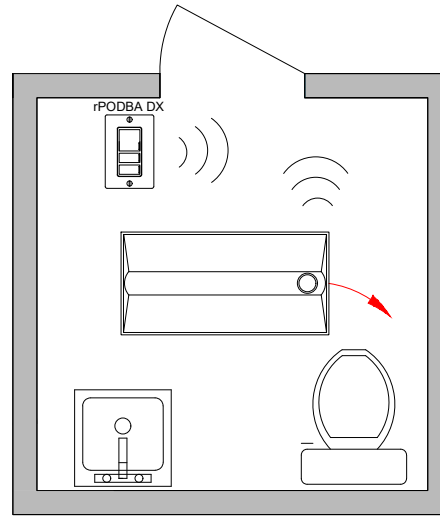

Wireless





Line Voltage Wires

Normal Power Feed

Bill of Materials

Symbol	Qty	Product #	Description
	1	See Note	Troffer with Wired Networked Embedded Controls from nLight
	1	nWSXA LV DX	Wall Switch Occupancy Sensor with On/Off, Raise/Lower

Bill of Materials

Symbol	Qty	Product #	Description
	1	See Note	Troffer with Wireless Networked Embedded Controls from nLight with Sensor Option
	1	rPODBA DX G2	Battery Powered, On/Off, Raise/Lower WallPod

/ OPERATION DETAILS:

Light Fixtures:

- All fixtures are dimmable
- Maximum level can be task tuned to any percentage via programming

Occupancy Control:

- Partial-on occupancy sensors automatically activate between 50-70% of controlled lighting power or fixtures must be turned on manually
- Fixture automatically turns off when room becomes vacant

Manual Control:

- On/off & raise/lower control of fixtures

/ ADDITIONAL OPTIONS:

- Room can be connected to nLight backbone to enable network control, time schedules and Automated Demand Response (OpenADR 2.0a)
- HVAC control available through system-wide BACnet® interface option on the ECLYPSE® controller
- Luminaires with wireless networked embedded controls from nLight with occupancy/daylighting sensor options available, please see the fixture specification sheet

Note: Contact your local lighting agent for more information on luminaires with networked embedded controls from nLight.

Luminaires with Wireless Networked Embedded Controls from nLight

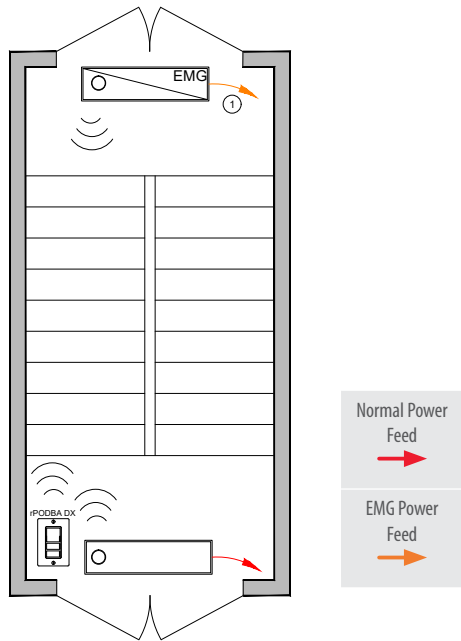

① Fixture(s) assumed to include nLight AIR EM emergency options. For battery backup option, no dedicated emergency circuit necessary. nLight AIR devices with an EM option must be grouped with a normal power sensing device to exit emergency operation. See control device spec sheet for details.

Wireless with 0-10V Dimming Fixtures

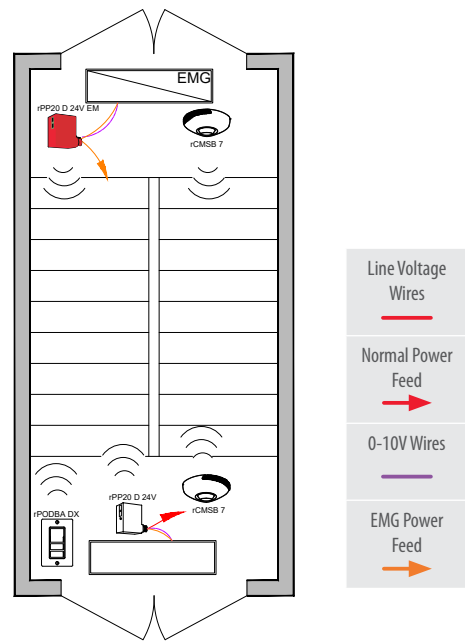

① nLight AIR devices with an EM option must be grouped with a normal power sensing device to exit emergency operation. See control device spec sheet for details.

Bill of Materials

Symbol	Qty	Product #	Description
	1	See Note	Luminaire with Wireless Networked Embedded Controls from nLight with Sensor Option
	1	See Note	Luminaire with Wireless Networked Embedded Controls from nLight with Sensor and Emergency Option
	1	rPODBA DX G2	Battery Powered, On/Off, Raise/Lower WallPod

Bill of Materials

Symbol	Qty	Product #	Description
	1	rPP20 D 24V EFP G2	Relay Pack with 0-10V Dimming Output
	1	rPP20 D 24V EM EFP G2	Emergency Relay Pack with 0-10V Dimming Output
	2	rCMSB PDT 7 G2	Battery Powered Occupancy Sensor
	1	rPODBA DX G2	Battery Powered, On/Off, Raise/Lower WallPod

/ OPERATION DETAILS:

Light Fixtures:

- All fixtures are dimmable
- All fixtures can be controlled together or independently
- Maximum level can be task tuned to any percentage via programming

Occupancy Control:

- Fixtures automatically turn off or optionally can be configured to drop to low dim setting of at least 50% when space becomes vacant

Daylight Control:

- Not required if room has < 24 ft² of glazing or lighting load < 120W in the skylit and the sidelit daylight zone
- Smooth continuous dimming
- Custom grouping of fixtures into separate daylight zones (max. number of zones = number of fixtures)

Manual Control:

- On/off & raise/lower control of fixtures

/ ADDITIONAL OPTIONS:

- Room can be connected to nLight backbone to enable network control, time schedules and Automated Demand Response (OpenADR 2.0a)
- HVAC control available through system-wide BACnet® interface option on the ECLYPSE® controller
- Luminaires with wireless networked embedded controls from nLight with occupancy/daylighting sensor options available, please see the fixture specification sheet

Note: Contact your local lighting agent for more information on luminaires with networked embedded controls from nLight.

Luminaires with Wireless Networked Embedded Controls from nLight

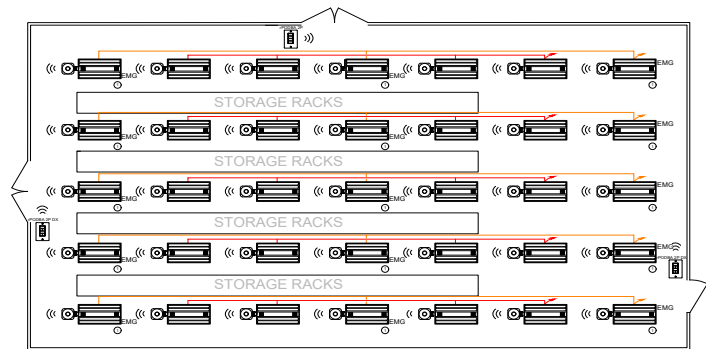

① Fixture(s) assumed to include nLight AIR EM emergency options. For battery backup option, no dedicated emergency circuit necessary. nLight AIR devices with an EM option must be grouped with a normal power sensing device to exit emergency operation. See control device spec sheet for details.



Bill of Materials

Symbol	Qty	Product #	Description
	20	See Note	High Bay with Wireless Networked Embedded Controls from nLight with Sensor Option
	15	See Note	High Bay with Wireless Networked Embedded Controls from nLight with Sensor and Emergency Option
	1	rPODBA 2P G2	Battery Powered, 2-Pole, On/Off WallPod
	2	rPODBA 2P DX G2	Battery Powered, 2-Pole, On/Off, Raise/Lower WallPod

/ OPERATION DETAILS:

Light Fixtures:

- All fixtures are dimmable
- Maximum level can be task tuned to any percentage via programming

Occupancy Control:

- Fixtures automatically turn off or optionally can be configured to drop to low dim setting of at least 50% when space becomes vacant

Daylight Control:

- Not required if room has < 24 ft². of glazing or lighting load < 120W in the skylit and the sidelit daylight zone
- Smooth continuous dimming

Wireless with 0-10V Dimming Fixtures

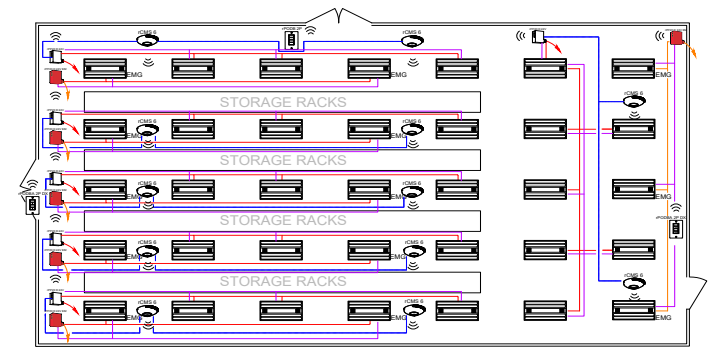

① nLight AIR devices with an EM option must be grouped with a normal power sensing device to exit emergency operation. See control device spec sheet for details.



Bill of Materials

Symbol	Qty	Product #	Description
	6	rPP20 D 24V EFP G2	Relay Pack with 0-10V Dimming Output
	6	rPP20 D 24V EM EFP G2	Emergency Relay Pack with 0-10V Dimming Output
	1	rPODBA 2P G2	Battery Powered, 2-Pole, On/Off WallPod
	2	rPODBA 2P DX G2	Battery Powered, 2-Pole, On/Off, Raise/Lower WallPod
	12	rCMS 6 G2	Occupancy Sensor

/ ADDITIONAL OPTIONS:

Manual Control:

- On/off control of two zones of fixtures

- Room can be connected to nLight backbone to enable network control, time schedules and Automated Demand Response (OpenADR 2.0a)
- HVAC control available through system-wide BACnet® interface option on the ECLYPSE® controller
- Luminaires with wireless networked embedded controls from nLight with occupancy/daylighting sensor options available, please see the fixture specification sheet

Note: Contact your local lighting agent for more information on luminaires with networked embedded controls from nLight.

Luminaires with Wireless Networked Embedded Controls from nLight

Wireless with 0-10V Dimming Fixtures

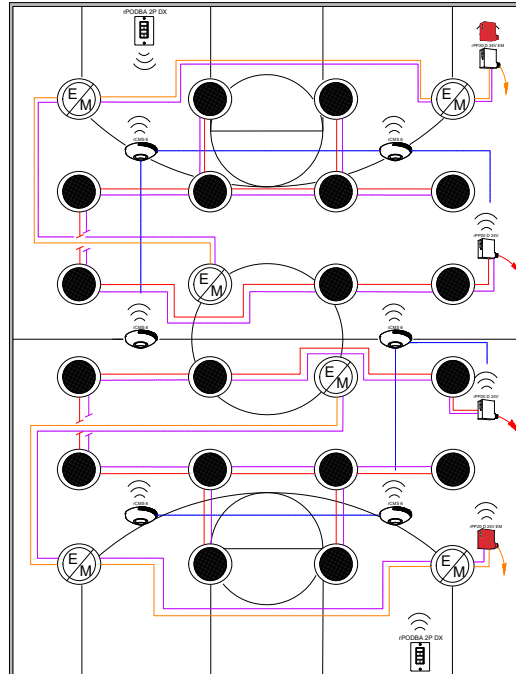
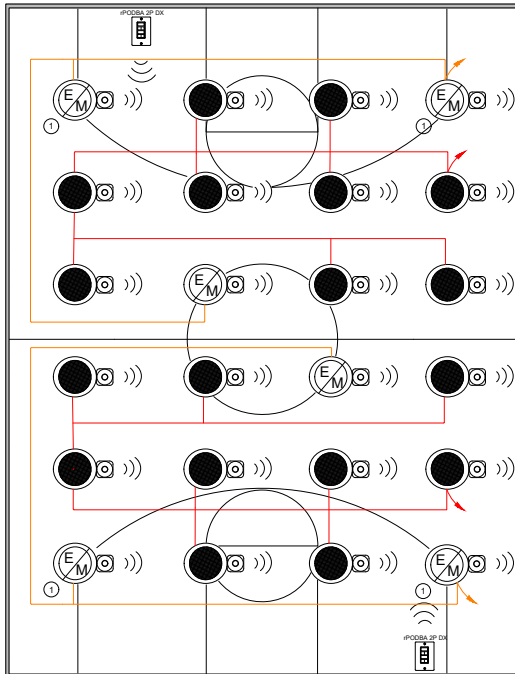

① Fixture(s) assumed to include nLight AIR EM emergency options. For battery backup option, no dedicated emergency circuit necessary. nLight AIR devices with an EM option must be grouped with a normal power sensing device to exit emergency operation. See control device spec sheet for details.

① nLight AIR devices with an EM option must be grouped with a normal power sensing device to exit emergency operation. See control device spec sheet for details.



Bill of Materials

Symbol	Qty	Product #	Description
	18	See Notes	Luminaire with Wireless Networked Embedded Controls from nLight with Sensor Option
	6	See Notes	Luminaire with Wireless Networked Embedded Controls from nLight with Sensor and Emergency Option
	2	rPODBA 2P DX G2	Battery Powered, 2-Pole, On/Off, Raise/Lower WallPod

Bill of Materials

Symbol	Qty	Product #	Description
	2	rPP20 D 24V EFP G2	Relay Pack with 0-10V Dimming Output
	2	rPP20 D 24V EM EFP G2	Emergency Relay Pack with 0-10V Dimming Output
	2	rPODBA 2P DX G2	Battery Powered, 2-Pole, On/Off, Raise/Lower WallPod
	6	rCMS 6 G2	High Bay Occupancy Sensor

/ OPERATION DETAILS:

Light Fixtures:

- All fixtures are dimmable
- Maximum level can be task tuned to any percentage via programming

Occupancy Control:

- Partial-on occupancy sensors automatically activate between 50-70% of controlled lighting power or fixtures must be turned on manually
- Fixture automatically turn off when room becomes vacant

Daylight Control:

- Not required if room has < 24 ft². of glazing or lighting load < 120W in the skylit and the sidelit daylight zone
- Smooth continuous dimming

Manual Control:

- On/off control of two zones of fixtures

/ ADDITIONAL OPTIONS:

- Room can be connected to nLight backbone to enable network control, time schedules and Automated Demand Response (OpenADR 2.0a)
- HVAC control available through system-wide BACnet® interface option on the ECLYPSE® controller
- Luminaires with wireless networked embedded controls from nLight with occupancy/daylighting sensor options available, please see the fixture specification sheet

Note: Contact your local lighting agent for more information on luminaires with networked embedded controls from nLight.

Wireless Parking Garage

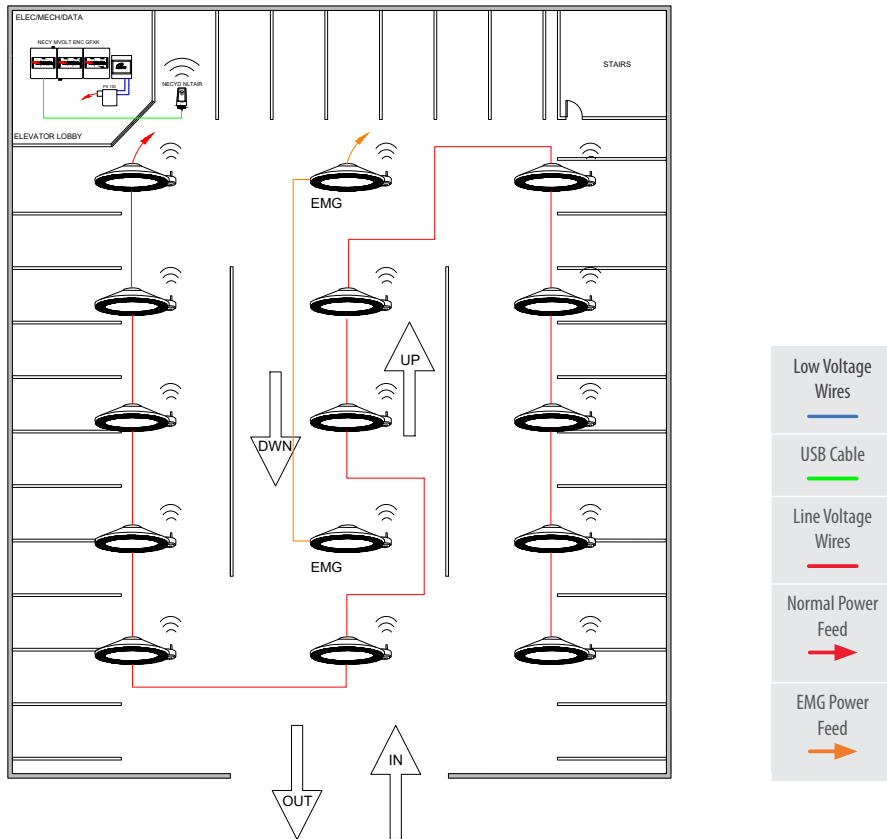

- ① Fixture(s) assumed to include nLight AIR EM emergency options. For battery backup option, no dedicated emergency circuit necessary. nLight AIR devices with an EM option must be grouped with a normal power sensing device to exit emergency operation. See control device spec sheet for details.

Bill of Materials

Symbol	Qty	Product #	Description
	13	See Note	Canopy with Wireless Networked Embedded Controls from nLight with Sensor Option
	2	See Note	Canopy with Wireless Networked Embedded Controls from nLight with Sensor and Emergency Option
	1	nECY	nLight ECLYPSE Network System Controller with Graphic Touchscreen
	1	nECYD NLTAIR G2	nLight AIR Adapter

/ OPERATION DETAILS:

Light Fixtures:

- All fixtures are dimmable
- All fixtures can be controlled together or independently
- Maximum level can be task tuned to any percentage via programming

Occupancy Control:

- Fixtures automatically turn off or optionally can be configured to drop to low dim setting of 20-50% when space becomes vacant

Daylight Control:

- Not required if room has < 36 ft². of glazing or lighting load < 60W in the sidelit daylight zone
- Smooth continuous dimming
- Custom grouping of fixtures into separate daylight zones (max. number of zones = number of fixtures)

Manual Control:

- On/off control of fixtures via graphic touchscreen on nECY

/ ADDITIONAL OPTIONS:

- Devices can be connected to nLight backbone to enable network control, time schedules and Automated Demand Response (OpenADR 2.0a)
- Luminaires with wireless networked embedded controls from nLight with occupancy/daylighting sensor options available, please see the fixture specification sheet

Note: Contact your local lighting agent for more information on luminaires with networked embedded controls from nLight.

Wireless Site Lighting

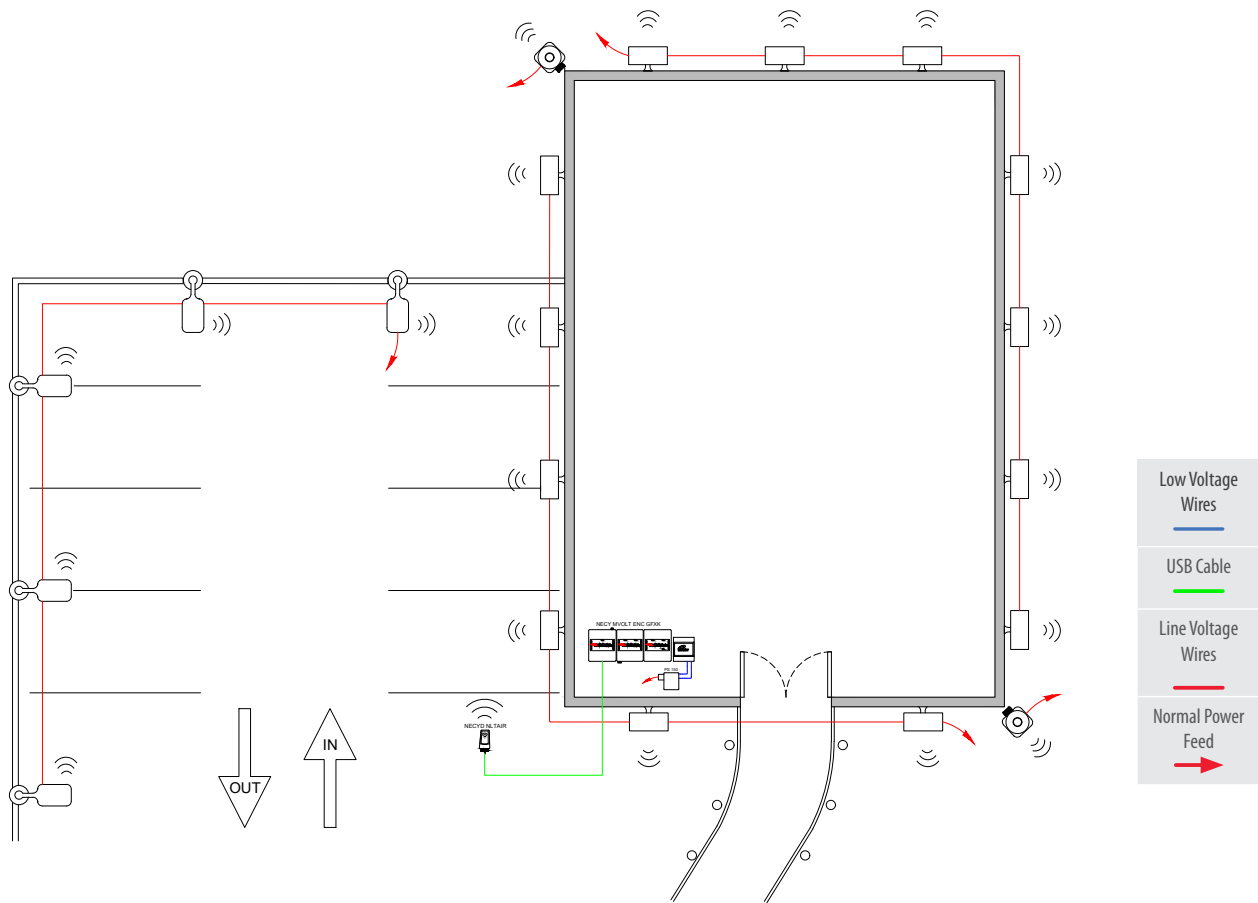

Bill of Materials

Symbol	Qty	Product #	Description
	5	See Note	Area Luminaire with Wireless Networked Embedded Controls from nLight
	13	See Note	Wall Mount with Wireless Networked Embedded Controls from nLight
	1	nECY	nLight ECLYPSE Network System Controller with Graphic Touchscreen
	1	nECYD NLTAIR G2	nLight AIR Adapter
	2	rSBOR	nLight AIR Repeaters

/ OPERATION DETAILS:

Light Fixtures:

- All fixtures are dimmable
- All fixtures can be controlled together or independently
- Maximum level can be task tuned to any percentage via programming

Occupancy Control:

- Fixtures automatically go to full bright when occupied
- Fixtures automatically turn off or optionally can be configured to reduce power by at least 50-90% when space becomes unoccupied

Daylight Control:

- Daylight responsive controls lights to full off when adequate daylight present

/ ADDITIONAL OPTIONS:

- Devices can be connected to nLight backbone to enable network control, time schedules, astronomical time schedules, and Automated Demand Response (OpenADR 2.0a)
- Luminaires with wireless networked embedded controls from nLight with occupancy/daylighting sensor options available, please see the fixture specification sheet



Note: Contact your local lighting agent for more information on luminaires with networked embedded controls from nLight.

nLight Hybrid Networked Lighting Control: Programmable Time Clock and Automatic Demand Response

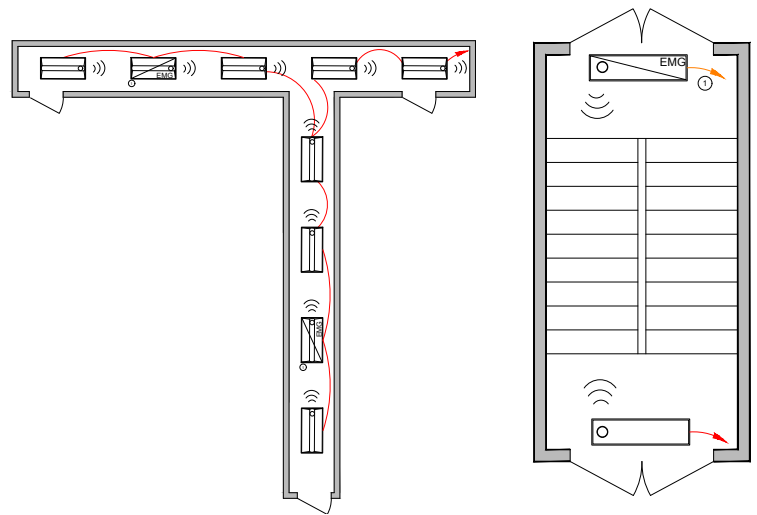
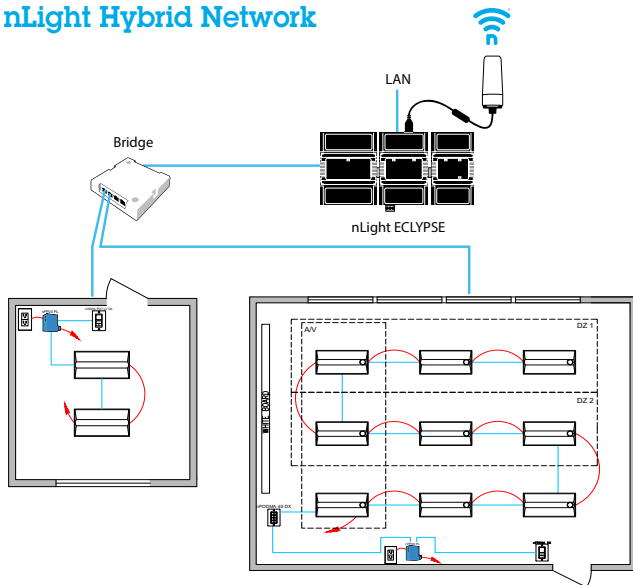
nLight Hybrid Network



Bill of Materials

Symbol	Qty	Product #	Description
	1	nBRG 8 KIT	8-Port Backbone Bridge
	1	nECY MVOLT ENC	nLight ECLYPSE Network System Controller and Optional BMS Interface
	1	nECYD NLTAIR G2	nLight AIR Adapter

Programmable Time Clock Control:

Although not pictured within each of the individual room design guides, each nLight Control Zone can be connected via an nLight backbone to create a networked nLight lighting control system capable of meeting the requirements of CA Title 24, Part 6, automatic time-switch and demand response provisions [sections 130.1(c)1 and 130.1(e), respectively]. A networked system also enables astronomical time clock control.

Automatic Demand Response (ADR):

In buildings with more than 4,000W of lighting power, lighting power must be capable of being automatically reduced by a minimum of 15% in response to an automatic demand response signal (ADR) to meet the requirements of CA Title 24, Part 6, demand response control [section 130.1(e)]. OpenADR is an open and standardized way for electricity providers to communicate demand response signals with their customers using a common language over any existing IP-based communications network, such as the Internet.

Luminaires with Networked Embedded Controls from nLight

Acuity Brands offers the industry's broadest portfolio of luminaire with networked embedded controls from nLight. Please scan the QR code to see the current luminaires with networked embedded controls from nLight.



Luminaire with Wireless Networked Embedded Controls from nLight



Luminaire with Wired Networked Embedded Controls from nLight

CLAIRITY™ + Mobile App

Quick and Easy Lighting Configuration and Control In the Palm of Your Hand

nLight Wired







The nLight Wired micro-application of CLAIRITY+ is a cost-effective method that simplifies programming and reduces start-up times for nLight devices in smaller projects.

The Bluetooth® word mark and logos are registered trademarks owned by Bluetooth SIG, Inc. and any use of such marks by Acuity Brands Lighting is under license.

nLight AIR









The nLight AIR application provides easy startup, configuration and modification of nLight® AIR wireless controls. This cloud connected app allows validated end users (electrical contractors, sales agents or facility maintenance professionals) to start up, configure and troubleshoot from a compatible smartphone or tablet.

Control Requirement		Code Provision	nLight Solution Details		
Area Control	130.1(a)	<p>nLight WallPod devices provide a user with local control of lighting within an nLight controlled space. WallPods are available in multiple styles – each with varying features and user experiences.</p>			
		Push-Button WallPod		Graphic WallPod*	
		<p>nPODMA Series rPODBA Series rPODLA nPODA Key</p> 		<p>nLight UNITOUCH Touchscreen Wall Switch</p> 	
		Traditional tactile buttons and LED user feedback.		Full-color touch screen provides a sophisticated look and feel.	
Shut-Off Control	Programmable Timeclock and Automatic Scheduling Controls	130.1(c)1 130.2(c)2	Network System Controller		
			<p>Network System Controller</p> 		
			<p>Individual nLight control groups (i.e.: rooms) can be easily networked together across an entire building simply by connecting them into a “backbone” made up of one or more nLight bridge devices and/or nLight AIR adapters and an nLight ECLYPSE system controller. The system controller provides programmable time clock functionality for an nLight network as well as interfaces to the SensorView suite of web-based software applications (via an Ethernet LAN / WAN connection).</p> <p>Additional benefits of installing an nLight backbone include remote status monitoring, system-wide configuration changes, and BMS interface capability, and ADR interface capability.</p>		
Automatic Full-Off via Occupancy Sensor	130.1(c) 5	<p>nLight occupancy sensors utilize 100% digital passive infrared (PIR) detection, come in several mounting styles, and offer multiple coverage pattern options. Additionally, nLight sensors are available with patented Microphonics™ dual technology detection for rooms with obstructions. Configuring for full off vs. partial off control is done with system programming.</p>			
Automatic Partial-Off via Occupancy Sensor	130.1(c) 6 & 7	360° Occupancy Sensor		120° WideView Corner Sensor*	
		<p>nCM Series rCMS Series rCMSB Series</p> 		<p>nWV Series</p> 	
		Surface mounts to ceiling tiles or sheetrock/plaster.		Directly mounts in corner or to ceiling via repositionable ceiling bracket.	

*Available with nLight Wired products only.

Note: This summary is for general information purposes only and is provided without any warranty as to accuracy, completeness, or otherwise. The user should read the applicable code sections for more complete and detailed descriptions of code requirements and exceptions and should consult with a professional engineering or other competent advisor before making any decision or taking any action based on this summary.

Control Requirement	Code Provision	nLight Solution Details	
Light Level Control	130.1(b) 130.2(c)1 130.2(c)3	<p>nLight provides multiple options for controlling continuous dimming luminaires. This allows spaces with several lighting types and technologies to be controlled together and with a common user experience.</p>	
		<p>Acuity Brands Luminaires with Networked Embedded Controls from nLight</p>	<p>Dimming Relay Packs</p>
			<p>nPP16 Series rPP20 Series</p> 
		<p>Acuity Brands offers a wide variety of LED fixtures with factory installed embedded controls from nLight that provide smooth continuous dimming.</p>	<p>nLight dimming relay enable control of any 0-10VDC dimmable LED luminaire.</p>
Automatic Multi-Level Daylight Controls	130.1(d)	<p>nLight offers standalone daylight harvesting sensors as well as occupancy sensors with integrated daylight harvesting. Sensors are available in various housings and provide continuous dimming control of any/all luminaires with networked embedded controls from nLight or dimming relay packs, each capable of being its own daylight zone.</p>	
		<p>Ceiling Mount Dimming Photocell</p>	<p>Recessed Mount Dimming Photocell*</p>
		<p>nCM Series rCMS Series rCMSB Series</p> 	<p>nRM Series</p> 
Additional Controls	130.5(d)	<p>The nLight Plug Load Relay Pack is capable of switching an entire 20A receptacle load. Simply add an occupancy sensor to an nLight Control Zone (room) and the sensor will automatically switch off when the room is vacant.</p>	
		<p>Plug Load / Receptacle Relay Pack</p>	
		 <p>nPP20 PL Series</p>	 <p>rPP20 Series</p>

Title 24 2022 and Emergency Lighting

The nLight platform offers flexible, UL 924 compliant control of emergency lighting. It addresses the needs of conventional projects that use extra wiring to charge battery packs inside of fixtures or to tell control devices to enter an emergency state when normal power is lost. Traditional lighting controls would make use of a shunt device in addition to a lighting control device (Figure 1). nLight consolidates the shunt device and lighting control device into a single digital device, which reduces installation and maximizes control (Figure 2). Wireless products also offer power detection through devices connected to normal power to initiate emergency control when normal power is lost. This modern method removes the need for extra wiring, further reducing the cost of installing emergency controls without sacrificing the intelligence and configurability that is expected from nLight devices (Figure 3).

- Areas designated as security or emergency areas that are required to be continuously lighted.
- Interior exit stairways, interior exit ramps and exit passageways.
- Emergency egress lighting that is normally off.
- Lighting for covered vehicle entrances or exits from buildings or parking structures where required for safety, security or eye adaptation.

Generally speaking, lighting that is normally on during occupied periods, normally dimmed or off during unoccupied periods, and also used to provide for egress during emergency power conditions should be controlled. nLight features various UL 924 listed options that can be specified to provide both lighting control in compliance with emergency operation.

Traditional Shunt

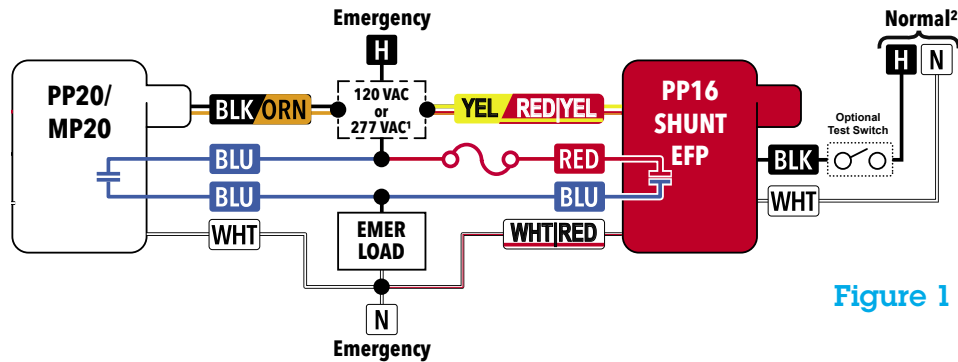

Figure 1

Control With Built-In Emergency Option Via Normal Power Sense

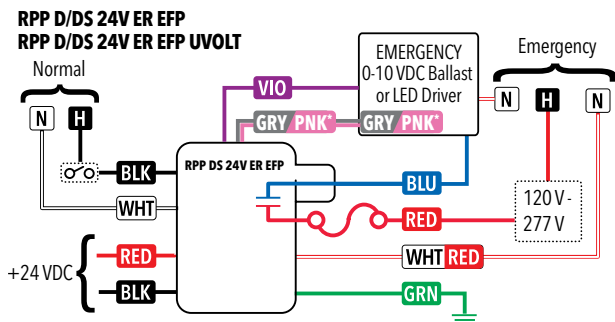

Figure 2

Control With Built-In Emergency Option Via nLight AIR EM

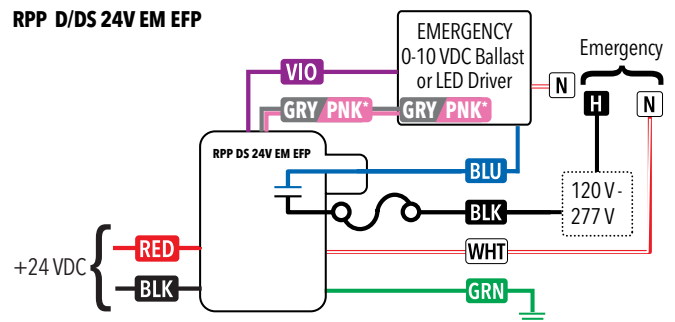

Figure 3



Title 24 2022 Applications Guide

In addition to being North America's leading manufacturer of indoor and outdoor luminaires, Acuity Brands offers an extensive portfolio of advanced lighting control and building technology solutions for indoor and outdoor applications, from single-room control to fully connected smart building management and space utilization. Our products, technology, expertise and support include occupancy and photosensors, centralized and distributed systems, panels, luminaire-integrated wired/wireless networked controls and IoT platform services, including space utilization solutions.

nLight Solution Typical Layout Drawings

<https://www.acuitybrands.com/resources/customer-tools/typicals>

California Energy Commission 2022 Energy Standards

<https://www.energy.ca.gov/programs-and-topics/programs/building-energy-efficiency-standards/2022-building-energy-efficiency>

California Lighting Technology Center

<https://cltc.ucdavis.edu/>

Energy Code Ace

<https://energycodeace.com/>

Use the Following Sections of the Title 24 Code as Reference:

- Section 100.1 – Definitions and rules of construction
- Section 110.9 – Mandatory requirements for lighting control devices and systems, ballasts and luminaires
- Section 130.0 – Lighting controls and equipment - general
- Section 130.1 – Indoor lighting controls that shall be installed
- Section 130.2 – Outdoor lighting controls and equipment
- Section 130.4 – Lighting control acceptance and installation certificate requirements
- Section 130.5 – Electrical power distribution systems
- Section 140.3 – Prescriptive requirements for building envelopes
- Section 140.6 – Prescriptive requirements for indoor lighting

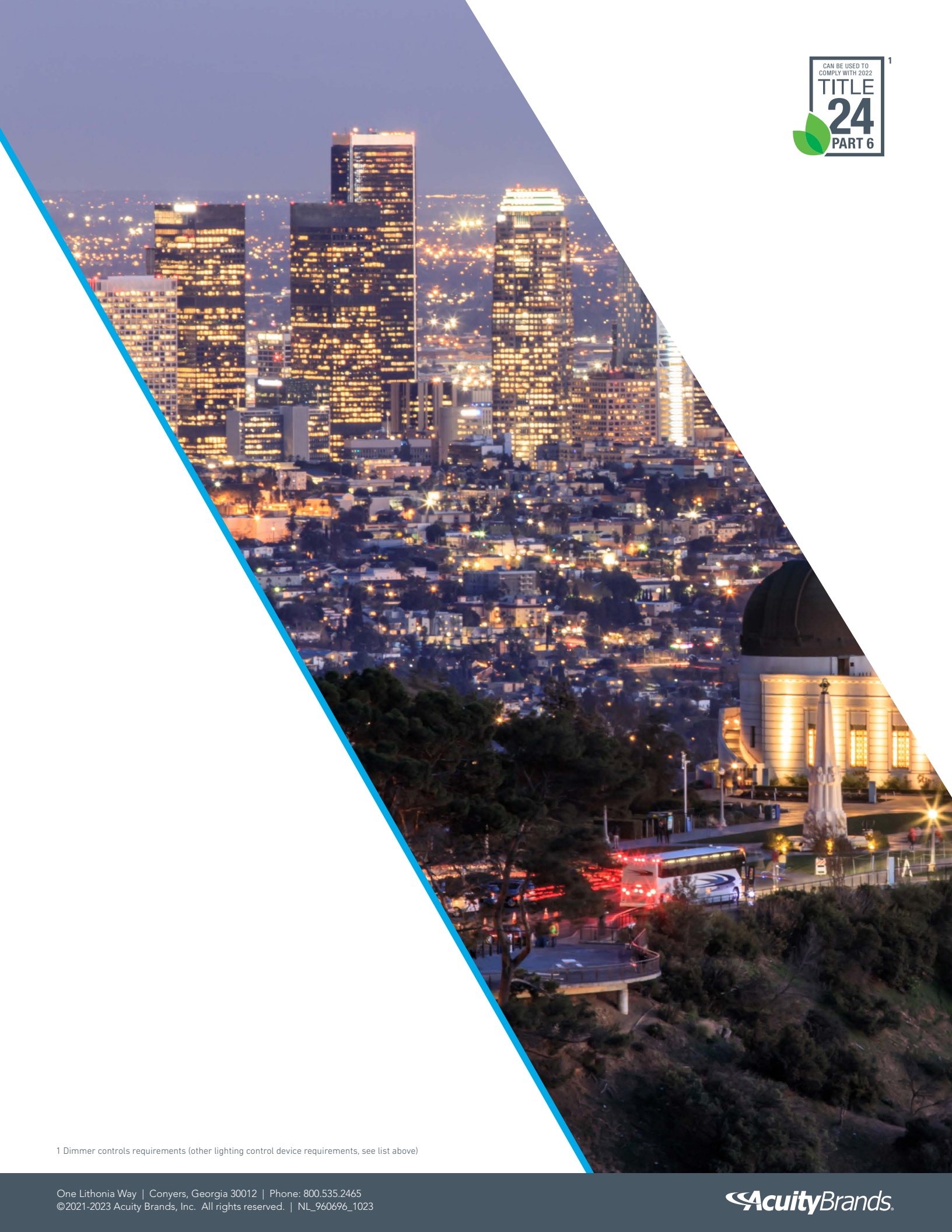

¹ Dimmer controls requirements (other lighting control device requirements, see list above)